

SPRAY PUMPS



TABLE OF CONTENTS

Pumps and Engines

Selecting the Right Pump	4
System Hook-Ups	11
Centrifugal Pumps	
Gear Driven Pumps	12
Pedestal & Flange Mount Pumps	15
Hydraulically Driven Pumps.....	28
Belt Driven Pumps Mont Pumps.....	54
Gas Engine Pumps.....	56
Seals.....	60
Self-Priming Adaptor (SPA).....	62
Centrifugal Pump Accessories.....	63
Transfer Pumps	
Transfer Pump Selections	64
Polypropylene Pumps	65
Transfer Pump Accessories	71
Cast-Iron Pumps.....	72
Aluminum Pumps.....	74
Roller Pumps	
Roller Pump Comparisons	76
Roller Pump Application Recommendations.....	77
Cast-Iron Pumps.....	78
Roller Pump Kits & Accessories.....	84
Other Pump Accessories	86
Shurflo Pumps	
Demand vs ByPass Pump	87
Shurflo Diaphragm Pumps.....	89
Shurflo Diaphragm Pump Accessories and Fittings.....	98
Shurflo Mini-Bulk Chemical Transfer Systems and Accessories.....	100
Specialty Pumps (Hydraulic-Driven Gear Pump and Aqua-Tiger)	103
PowerPro Gasoline Engines	105
Limited Warranty on Hypro/Shurflo Pumps and Other Hypro Products	106

PUMPS AND ENGINES

CENTRIFUGAL PUMPS PAGE 12

Commonly used with self-propelled sprayers, large-trailed sprayers, and construction equipment

- ◆ Material OPTIONS Cast Iron, Polypropylene, 316 Stainless Steel
- ◆ Pressure Range: 0-150 psi (0-10 bar)
- ◆ Flow Range: 0-1078 GPM (0-4080 LPM)

TRANSFER PUMPS..... PAGE 64

Commonly used with tender trailers and fluid transfer stations

- ◆ Material OPTIONS Polypropylene, Aluminum, Cast Iron
- ◆ Pressure Range: 0-55 psi (0-3.8 bar)
- ◆ Flow Range: 0-460 GPM (0-1740 LPM)

ROLLER PUMPS.....PAGE 76

Commonly used with 3-point sprayers, pest control, and de-icing skids

- ◆ Material OPTIONS Cast Iron, Ni-Resist, Silver Series XL
- ◆ Pressure Range: 0-300 psi (0-20 bar)
- ◆ Flow Range: 0-60 GPM (0-227 LPM)

SHURFLO DIAPHRAGM PUMPSPAGE 87

Commonly used with ATV sprayers and nutrient application systems

- ◆ Material OPTIONS Polypropylene, Nylon
- ◆ Pressure Range: 0-150 psi (0-10 bar)
- ◆ Flow Range: 0-5 GPM (0-19 LPM)

SPECIALTY PUMPS PAGE 103

- ◆ Aqua-Tiger: general pumping applications where a flooded intake is provided

POWERPRO ENGINES PAGE 105

SELECTING THE RIGHT PUMP

Because the pump is the “heart of the liquid system” on equipment, careful consideration must be made in selecting the right pump. Seldom is there only one pump that will do the job. To make a wise choice, you will need to know about pump types, how the pump is driven, and the flow and pressure requirements for your specific spraying system and application.

PUMP TYPES

To ensure you can closely match the pump to your needs, Pentair manufactures six different types of pumps under the Hypro and Shurflo brands: centrifugal, transfer, roller, diaphragm, piston and plunger pumps.



“Positive displacement” vs. “Non-positive placement”

Pumps can be divided into two general categories: “positive displacement” and “non-positive displacement.”

Positive Displacement – In a positive displacement pump the flow from the pump is directly proportional to the pump speed. Liquid is captured and discharged as a fixed volume per revolution of the pump shaft. This positive flow is why all positive displacement pump installations must include a relief valve and bypass line between the pump outlet and the nozzle shut-off valve. Roller, diaphragm, gear, piston and plunger pumps are positive displacement pumps.

Non-positive Displacement – In a non-positive displacement pump a rotating impeller creates a centrifugal force that overcomes the restriction of liquid flow through the system. If the outlet is closed, the impeller continues to rotate harmlessly without damaging system components. Centrifugal and transfer pumps are non-positive displacement pumps.



Centrifugal Pumps -Spray & Transfer Applications (Non-positive Displacement)

In centrifugal pumps, liquid enters through the center of a rotating impeller that is driven at speeds up to 6000 RPM. Liquid is forced to the outer edge of the housing; this centrifugal force is what delivers the liquid to the nozzle. Traditionally thought of as low to medium pressure pumps, the Hypro line of centrifugal pumps can deliver from 0-150 psi (0-10 bar) and flow rates up to 440 GPM (1760 LPM). 1078 GPM [4080 LPM] is the max flow achieved by the specialty 9308 series centrifugal pumps. Centrifugal pumps have minimum surfaces to wear and no poppet valves, making them very durable, easy to maintain and well suited for pumping abrasive and corrosive materials. Because centrifugal pumps operate at higher speeds than the RPMs of a tractor PTO, the speed must be increased through a gear drive, belt drive, gas engine drive, or high-speed hydraulic motor drive. Pump models are specifically designed for each of these drive

applications. The broad, versatile line includes models with rugged housings and components of cast iron, polypropylene, engineered plastics and stainless steel that endure the wide variety of agricultural chemicals.

SELECTING THE RIGHT PUMP

Diaphragm Pumps (Positive Displacement)

Diaphragm pumps are designed to isolate abrasive and corrosive solutions being pumped from its mechanical drive components through the use of synthetic diaphragms.

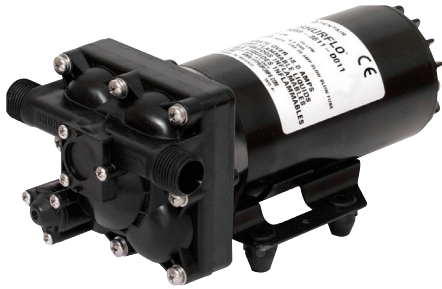

Shurflo pumps are efficient, 12 VDC electric motor driven low pressure diaphragm pumps designed for smaller spray applications with pressures 0-150 psi (0-10 bar) and flows 0-5.3 GPM (0-20 LPM). Shurflo pumps fit uniquely into mobile applications on ATV, home lawn care, fertilizer and pesticide equipment.

Roller Pumps (Positive Displacement)

The Hypro line of roller pumps are an economical choice by farmers throughout the world. The rollers revolve inside the pump housing on an eccentric profile to force spray solution through the pump which then develops pressure and flow. The roller pump offers a compact design with mechanical simplicity to provide a low initial cost pump that is extremely versatile.



They operate efficiently at PTO speeds of 540 and 1000 rpm and have a wide pressure range of up to 300 psi (20 bar) and flow rates of 2 to 62 GPM (7 to 235 LPM). Roller pumps are self-priming and easily adapt to PTO or gas engine drives. Specific seal, roller and casting materials can be selected for compatibility with certain herbicides, pesticides, fungicides and fertilizers.

SELECTING THE RIGHT PUMP

PUMP DRIVES

How a pump is to be driven is often a primary consideration in selecting the proper type of pump. If the power source has already been determined, the following chart may be of further help in selecting the type of pump that is best suited to your needs.

HOW DO YOU PLAN TO DRIVE THE PUMP?

Power Source	Method	Roller	Centrifugal and Transfer	Diaphragm
540 rpm PTO	Direct coupled:	X		
	Through gear drive:		X	
	Through belt/pulley:		X	
1000 rpm PTO	Direct coupled:	X		
	Through gear drive:		X	
	Through belt/pulley:		X	
Hydraulic Motor		X	X	
12 Volt DC Motor		X		X
Gas Engine	Direct coupled:	X	X	
	Through gear reduction:	X		
	Through belt/pulley:	X	X	
Electric Motor	Direct coupled:	X	X	X
	Through belt/pulley:	X	X	

SELECTING THE RIGHT PUMP

FLOW AND PRESSURE REQUIREMENTS

Pump pressure required is often dependent on the application. Whether it be low pressure band spraying or high pressure tree spraying, it is the application that dictates what pressure is needed to get the right performance at the spray nozzle. Once you know what pressure is desired choose a pump with extra pressure capacity due to losses in pressure as it goes through the system components (strainer, valves, elbows, hose, etc.) out to the nozzle.

HOW MUCH PRESSURE DO YOU NEED?

Pressure		Flow		Pump
0-150 psi (0-10 bar)		0-1078 GPM (0-4080 LPM)		Centrifugal
0-150 psi (0-10 bar)		0-10 GPM (0-40 LPM)		Shurflo Diaphragm
0-300 psi (0-20 bar)		0-60 GPM (0-225 LPM)		Roller

Pump flow required is dependent on several factors. Application rate, width of boom or size of nozzle, speed of travel and agitation. To review your pump flow requirements follow through the calculations presented on the following pages. As with pressure you will want to choose a pump that has additional flow so that it meets your application needs over time as performance drops due to component wear.

HOW MUCH FLOW DO YOU NEED?

FLOW		PRESSURE		PUMP
0-5 GPM (0-20 LPM)		0-150 psi (0-10 bar)		Shurflo Diaphragm
0-60 GPM (0-225 LPM)		0-300 psi (0-20 bar)		Roller
0-1078 GPM (0-4080 LPM)		0-150 psi (0-10 bar)		Centrifugal

SELECTING THE RIGHT PUMP

Determining Pump Flow and Pressure Requirements

Every pumping task has an optimum volume and pressure requirement. Determining that optimum (and selecting the pump that delivers it) is key to an efficient and economical spraying system operation.

Pressure requirements for agricultural pumps are dependent on both the material to be applied and application targets. Soil-applied herbicides generally require a relatively low pressure pump rating of 30-60 psi with foliar-applied herbicides at the top end of that range and slightly higher. Insecticides and fungicides can require higher pressure ratings of 100 to 500 psi. Pressure must be sufficient, in the case of heavy foliage field crops and orchard crops, to penetrate the leaf foliage. In the case of orchard crops, pressure must also be sufficient to carry material up and over as well as into the canopy.

A number of factors must be considered to properly determine the total flow you will need from your pump. They include:

- ◆ Type of spray operation (broadcast, banding, low-level, etc.)
- ◆ The chemical's application rate, ground speed, boom width, hose length, tank agitation, etc.

The spray task is the first consideration in determining flow rate and pressure needs. The following formulas and calculations may help.

Calculating Agitation Requirements

The pump must produce enough flow for both the application rate and tank agitation requirements. Too little agitation will not keep the solution in proper suspension and too much agitation may cause foaming. Here are rule of thumb formulas for calculating how much additional pump flow you will need for agitation.

Liquids:

$$\text{Tank volume (gallons)} \times .05 = \text{total agitation in GPM}$$

or

$$\text{Tank volume (litres)} \times .05 = \text{total agitation in LPM}$$

Wetable Powders and Flowables:

$$\text{Tank volume (gallons)} \times .125 = \text{total agitation in GPM}$$

or

$$\text{Tank volume (litres)} \times .125 = \text{total agitation in LPM}$$

EXAMPLE: If you will be spraying a wettable powder from a 100-gallon tank, proper agitation will require 12.5 GPM additional flow from the pump.

Reducing Agitation Flow Requirements

Agitation flow requirements can be reduced by using jet agitation in the tank. Jet agitators use a venturi design to multiply agitation output. Depending on the jet agitator model and pressure, one gallon per minute input can provide two to ten gallons per minute agitation output. If your sprayer is equipped with a jet agitator, consult the operator's manual or documentation to find the output to input ratio and adjust your flow required for agitation accordingly.

Agitation Flow with Jet Agitation:

$$\text{Required GPM} \times \frac{\text{Input}}{\text{Output}}$$

or

$$\text{Required LPM} \times \frac{\text{Input}}{\text{Output}}$$

For example: If you calculate a requirement of 63 GPM of agitation and your jet agitator produces 3 to 1 output to input ratio, your pump would only need 1/3 of 63 GPM, or 21 GPM.

SELECTING THE RIGHT PUMP

Factor in an "Excess Flow" Requirement

It is wise to have some excess flow capacity so you will not end up with an undersized pump because actual operation conditions may cause changes in spray system performance (such as normal pump wear, operating at less than rated speeds, etc.). Hypro/ Shurflo recommends you add an additional 20% to your calculated total pump flow requirement to compensate for these variables. Plumbing systems have a number of restrictions that will result in a pressure drop from the pump to the actual spray point. These must be taken into account and minimized.

Calculating Pump Flow for Broadcast Boom Sprayers

Chemical application is measured in gallons per acre (GPA) or litres per hectare (l/ha), whereas pump flow is stated in gallons per minute (GPM) or litres per minute (LPM). To calculate the pump flow required by a broadcast boom sprayer, multiply the application rate (from the chemical label) by the sprayer ground speed. Multiply the sum by the boom width on your sprayer. Then, divide that number by 495 for US units or by 600 for metric units. As a formula, it is written like this:

Flow required for boom:

$$\text{GPM} = \frac{\text{GPA} \times \text{mph} \times \text{boom width (ft.)}}{495}$$

or

$$\text{LPM} = \frac{\text{l/ha} \times \text{km/hr} \times \text{boom width (m)}}{600}$$

The result will be the pump flow required to deliver the proper application rate at the boom's nozzles. Then calculate your total pump flow requirement (broadcast):

Flow required for boom	_____ GPM
Flow required for agitation	+ _____ GPM
Sub-total	= _____ GPM
Excess flow requirement	x <u>1.20</u>
TOTAL PUMP FLOW NEEDED	_____ GPM

OR

Flow required for boom	_____ LPM
Flow required for agitation	+ _____ LPM
Sub-total	= _____ LPM
Excess flow requirement	x <u>1.20</u>
TOTAL PUMP FLOW NEEDED	_____ LPM

Calculating Pump Flow for Banding Sprayers

First, multiply the band width by the number of rows to determine the total width (w). Then, multiply the application rate (from the chemical label) by the ground speed. Multiply that result by the total width (w) calculated earlier, then divide the result by 5940 for US units or 60,000 for metric units. Here's how the formula appears:

Total band width of sprayer:

$$w = \text{rows} \times \text{band width (inches)}$$

or

$$w = \text{rows} \times \text{band width (cm)}$$

Flow required for banding nozzles:

$$\text{GPM} = \frac{\text{GPA} \times \text{mph} \times w}{5940}$$

or

$$\text{LPM} = \frac{\text{l/ha} \times \text{km/hr} \times w}{60,000}$$

The result will be the pump flow required to deliver the proper application rate at the boom's nozzles. Then calculate your total pump flow requirement (banding):

Flow required for boom	_____ GPM
Flow required for agitation	+ _____ GPM
Sub-total	= _____ GPM
Excess flow requirement	x <u>1.20</u>
TOTAL PUMP FLOW NEEDED	_____ GPM

OR

Flow required for boom	_____ LPM
Flow required for agitation	+ _____ LPM
Sub-total	= _____ LPM
Excess flow requirement	x <u>1.20</u>
TOTAL PUMP FLOW NEEDED	_____ LPM

SELECTING THE RIGHT PUMP

Calculating Pump Flow for Hand Gun Spraying

For low-level spraying with a hand gun, such as for lawn and turf care, professional applicators typically “walk” the lawn at about 1,000 sq. ft. per minute or 100 sq. m per minute. That means the “GPM” or “LPM” rate of the hand gun will generally be the same as “gallons per 1,000 sq. ft.” or “litres per 100 sq. m.”

To Determine Your Total Pump Flow Requirement:

Flow required for gun/nozzle:	_____	Litres per 1,000ft ² (same as GPM)
Flow required for agitation: +	_____	GPM
Sub-total =	_____	GPM
Excess flow requirement: x	1.20	
TOTAL PUMP FLOW NEEDED:	_____	GPM

Flow required for gun/nozzle:	_____	Litres per 1,000ft ² (same as GPM)
Flow required for agitation: +	_____	LPM
Sub-total =	_____	LPM
Excess flow requirement: x	1.20	
TOTAL PUMP FLOW NEEDED:	_____	LPM

Use this same method for calculating the pump flow requirement for high pressure spraying, such as trees. Even though the application “rate” is usually a visual saturation of the tree, the known GPM or LPM factor will be the hand gun nozzle output, which is the rate you use for the calculation.

Calculating Pump Pressure for Hand Gun Spraying

For most hand gun chemical spraying, 40 psi (3 bar) at the nozzle is typical. To properly select a pump that can deliver the right nozzle pressure, you must consider the normal “pressure drop” that occurs within the length of hose. The amount of pressure drop through the hose depends on hose length, hose diameter and flow rate. For example, 300’ (90 m) of 1/2” hose spraying at 6 GPM (23 LPM), will have a pressure drop of approximately 120 psi (8 bar). That means you need a pump delivering at least 160 psi (12 bar) in order to ensure 40 psi (3 bar) at the nozzle.

Desired pressure at gun nozzle:	_____	psi
Hose pressure loss: +	_____	psi
TOTAL PUMP PRESSURE NEEDED: =	_____	psi

or

Desired pressure at gun nozzle:	_____	bar
Hose pressure loss: +	_____	bar
TOTAL PUMP PRESSURE NEEDED: =	_____	bar

NOTE: When determining the total pump pressure requirement for high tree spraying, you must also consider the spray height (or reach) you need to attain. Generally, pumps of up to 700 psi (50 bar) are used for this purpose.

Pressure Loss at Various Rates of Flow of Water Through Hose (1/4-inch to 1-inch inside diameter) at temperature of 68° Fahrenheit (20°C.)

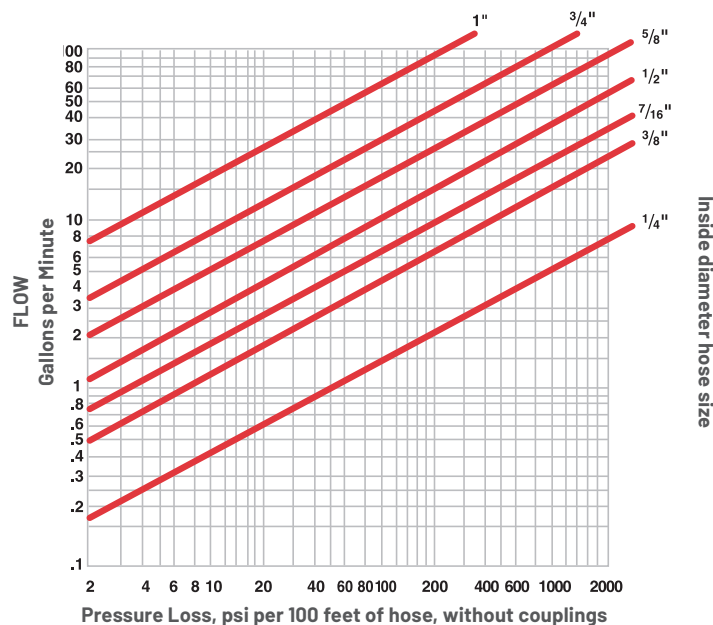

SYSTEM HOOK-UPS

Centrifugal Pumps

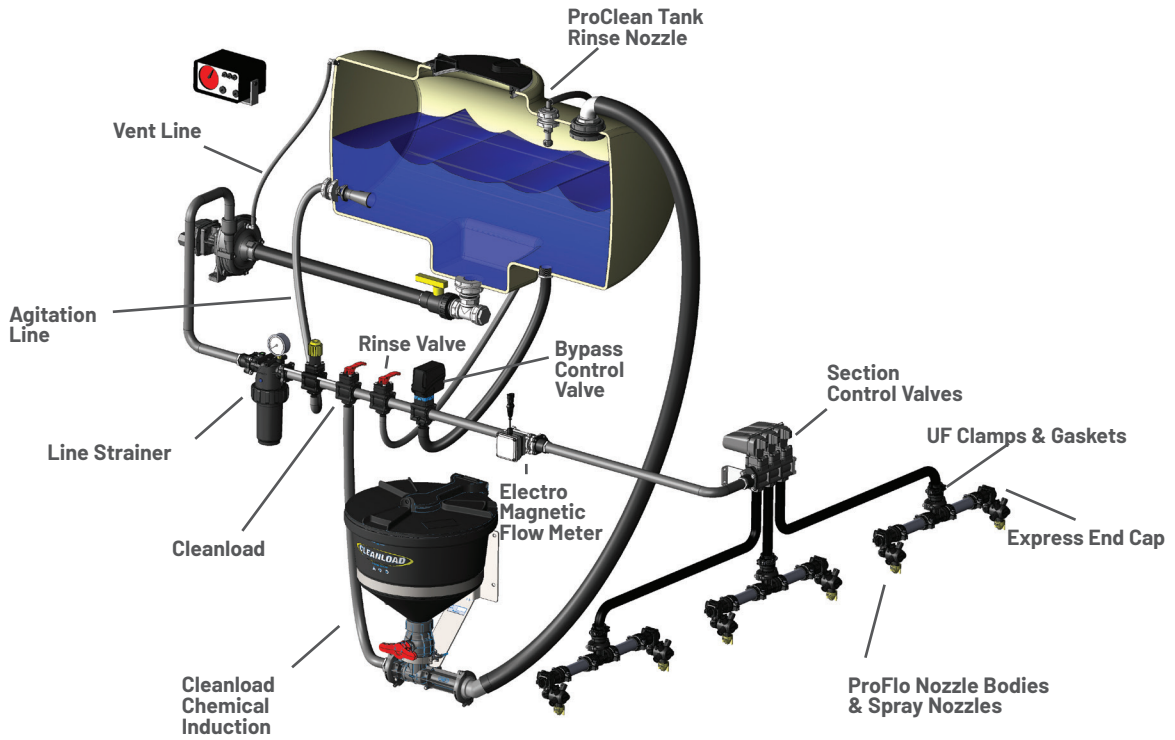

SYSTEM HOOK-UPS

Roller Pumps

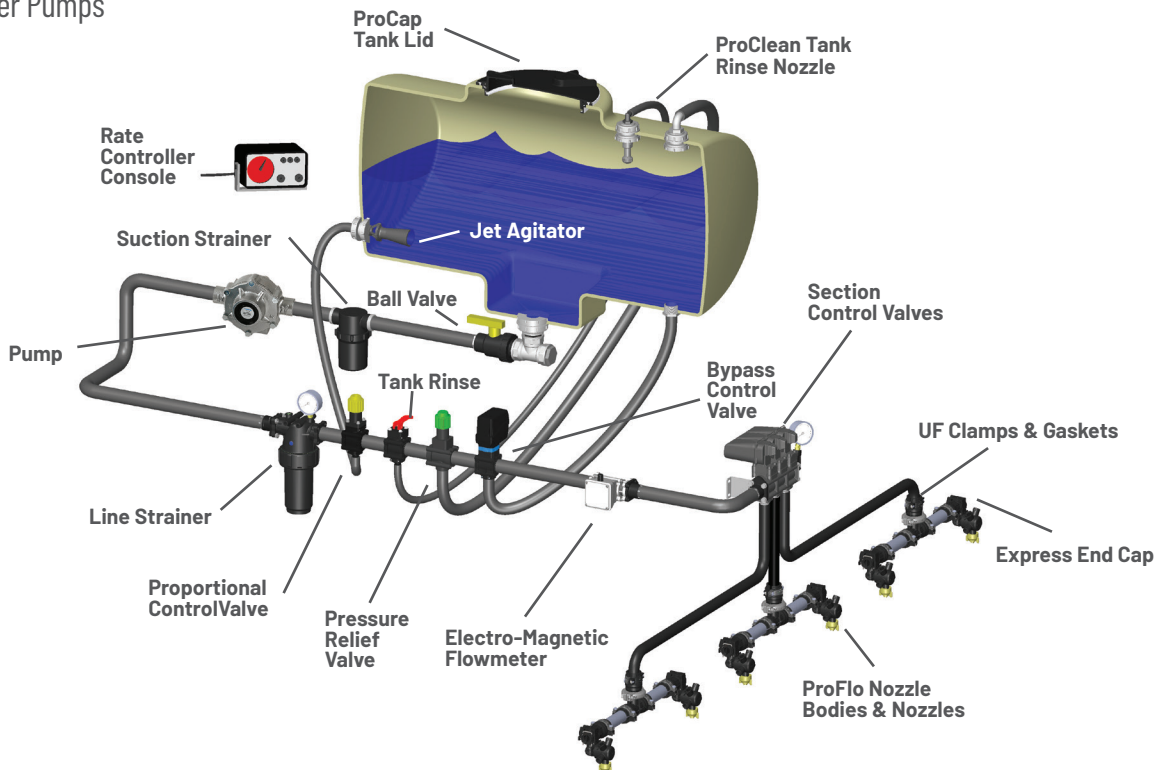

Hypro carries all parts labeled above. Please contact your local Hypro dealer by using the "Where to Buy" function on our website at pentair.com, or call 1-800-424-9776 for more information.

9000C-0 Series

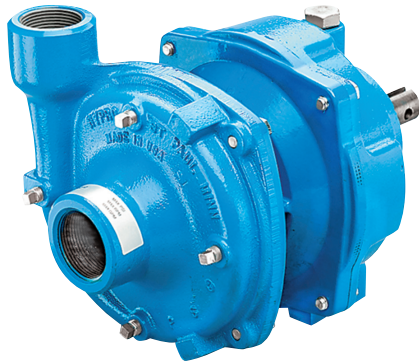

FEATURES

- ◆ Planetary oil-bath gear drive
- ◆ Port sizes: 1-1/2" NPT inlet, 1-1/4" NPT outlet
- ◆ Max. fluid temperature: 140°F/60°C
- ◆ Housing: Cast iron
- ◆ Impeller: Nylon
- ◆ Pump shaft rotation: Counter clockwise when looking at the shaft end
- ◆ Pump seals: Viton®/ceramic standard; Life Guard silicon carbide (B) available
- ◆ Life Guard seals are the industry standard on OEM equipment
- ◆ Weight: 44 lbs./20 kg

UPGRADE OPTIONS

- ◆ Increase dry-run and abrasive resistance with Life Guard Seals
 - Life Guard seals are the OEM standard

ORDERING INFORMATION

Model Number	Max GPM	Max LPM	Max PSI	Max BAR	Max RPM	PTO Output	Locking Collar and Mounting Clip
9006C-0	117	443	78	5.4	600	1-3/8" 6 spline (SAE) 540 rpm female	X
9008C-0	110	416	75	5.2	1000	1-3/8" 21 spline (SAE) 1000 rpm female	X
9016C-0	117	443	78	5.4	600	1" (25.4 mm) Solid Shaft	
9018C-0	110	416	75	5.2	1000	1" (25.4 mm) Solid Shaft	
9028C-0	110	416	75	5.2	1000	1-3/4" 20 spline (SAE) 1000 rpm female	X
3430-0334	Seal and o-ring repair kit						
3430-0591	Life Guard silicon carbide seal kit						

Life Guard silicon carbide seal - Add suffix "B" (i.e.: 9006C-0-B)

9006C-0, 9016C-0

U.S. UNITS

RPM	GPM at 20 PSI	GPM at 30 PSI	GPM at 40 PSI	GPM at 50 PSI	GPM at 60 PSI	GPM at 70 PSI
500	97	86	71	47		
540	106	96	87	70	47	
600	117	113	104	96	82	63

9008C-0, 9018C-0, 9028C-0

U.S. UNITS

RPM	GPM at 20 PSI	GPM at 30 PSI	GPM at 40 PSI	GPM at 50 PSI	GPM at 60 PSI	GPM at 70 PSI
800	82	70	53			
900	96	88	76	60	24	
1000	110	102	96	86	70	46

9006C-0, 9016C-0

METRIC UNITS

RPM	LPM at 1.4 BAR	LPM at 2.1 BAR	LPM at 2.8 BAR	LPM at 3.4 BAR	LPM at 4.1 BAR	LPM at 4.8 BAR
500	367	326	269	178		
540	401	363	329	265	178	
600	443	428	394	363	310	238

9008C-0, 9018C-0, 9028C-0

METRIC UNITS

RPM	LPM at 1.4 BAR	LPM at 2.1 BAR	LPM at 2.8 BAR	LPM at 3.4 BAR	LPM at 4.1 BAR	LPM at 4.8 BAR
800	310	265	201			
900	363	333	288	227	91	
1000	416	386	363	326	265	174

9000C-0-SP Series



FEATURES

- ◆ Planetary oil-bath gear drive
- ◆ Port sizes: 1-1/2" NPT inlet, 1-1/4" NPT outlet
- ◆ Max. fluid temperature: 140°F/60°C
- ◆ Housing: Cast iron
- ◆ Impeller: Nylon
- ◆ Pump shaft rotation: Counter clockwise when looking at the shaft end
- ◆ Pump seals: Viton®/ceramic standard; Life Guard silicon carbide (B) available
- ◆ Life Guard seals are the industry standard on OEM equipment
- ◆ Weight: 62 lbs./28.2 kg

UPGRADE OPTIONS

- ◆ Increase dry-run and abrasive resistance with Life Guard Seals
 - Life Guard seals are the OEM standard

ORDERING INFORMATION

Model Number	Max GPM	Max LPM	Max PSI	Max BAR	Max RPM	PTO Output	Locking Collar and Mounting Clip
9006C-0-SP	119	450	77	5.3	600	1-3/8" 6 spline (SAE) 540 rpm	X
9016C-0-SP	119	450	77	5.3	600	1" (25.4 mm) solid shaft	
9028C-0-SP	117	443	69	4.35	1000	1-3/4" 20 spline (SAE) 1000 rpm	X
3430-0334						Seal and o-ring repair kit	
3430-0591						Life Guard silicon carbide seal kit	
3430-0480SP						Self priming chamber kit	

Life Guard silicon carbide seal - Available upon request

9006C-0-SP, 9016C-0-SP

U.S. UNITS

RPM	GPM at 10 PSI	GPM at 20 PSI	GPM at 30 PSI	GPM at 40 PSI	GPM at 50 PSI	GPM at 60 PSI	GPM at 70 PSI
500	101	95	77	51	12		
540	111	109	94	74	47	11	
600	119	118	112	97	79	54	23

9028C-0-SP

U.S. UNITS

RPM	GPM at 10 PSI	GPM at 20 PSI	GPM at 30 PSI	GPM at 40 PSI	GPM at 50 PSI	GPM at 60 PSI	GPM at 70 PSI
800	91	81	57	19			
940	105	101	84	60	25		
1000	117	114	104	87	65	33	23

9006C-0-SP, 9016C-0-SP

METRIC UNITS

RPM	LPM at 0.7 BAR	LPM at 1.4 BAR	LPM at 2.1 BAR	LPM at 2.8 BAR	LPM at 3.4 BAR	LPM at 4.1 BAR	LPM at 4.8 BAR
500	382	360	291	193	45		
540	420	413	356	280	178	42	
600	450	447	424	367	299	204	87

9028C-0-SP

METRIC UNITS

RPM	LPM at .07 BAR	LPM at 1.4 BAR	LPM at 2.1 BAR	LPM at 2.8 BAR	LPM at 3.4 BAR	LPM at 4.1 BAR	LPM at 4.8 BAR
800	344	307	216	72			
940	397	382	318	227	95		
1000	443	432	394	329	246	125	87

9000P-0 Series

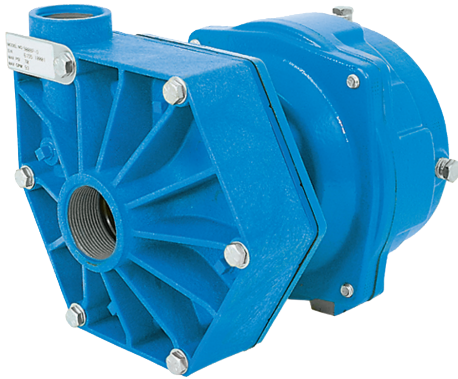

FEATURES

- ◆ Planetary oil-bath gear drive
- ◆ Port sizes: 1-1/2" NPT inlet, 1-1/4" NPT outlet
- ◆ Max. fluid temperature: 140°F/60°C
- ◆ Housing: Polypropylene
- ◆ Impeller: Polypropylene
- ◆ Pump shaft rotation: Counter clockwise when looking at the shaft end
- ◆ Pump seals: Viton®/ceramic standard; Life Guard silicon carbide (B) available
- ◆ Life Guard seals are the industry standard on OEM equipment
- ◆ Weight: 37 lbs./16.8 kg

UPGRADE OPTIONS

- ◆ Increase abrasive resistance with Life Guard Seals
 - Life Guard seals are the OEM standard

ORDERING INFORMATION

Model Number	Max GPM	Max LPM	Max PSI	Max BAR	Max RPM	PTO Output	Locking Collar Kit
9006P-0	97	367	83	5.7	600	1 3/8" 6 spline (SAE) 540 rpm female	X
9008P-0	94	355	67	4.6	1000	1 3/8" 21 spline (SAE) 1000 rpm female	X
9016P-0	97	367	83	5.7	600	1" (25.4 mm) solid shaft	
9018P-0	94	355	67	4.6	1000	1" (25.4 mm) solid shaft	
3430-0333	Seal and o-ring repair kit						
3430-0590	Life Guard silicon carbide seal kit						

Life Guard silicon carbide seal - Add suffix "B" (i.e.: 9006P-0-B)

9006P-0, 9016P-0

U.S. UNITS

RPM	GPM at 10 PSI	GPM at 20 PSI	GPM at 30 PSI	GPM at 40 PSI	GPM at 50 PSI	GPM at 60 PSI	GPM at 70 PSI
450	73	63	52	34			
500	81	77	67	55	37		
550	88	85	78	68	56	36	
600	97	97	93	85	76	66	52

9008P-0, 9018P-0

U.S. UNITS

RPM	GPM at 10 PSI	GPM at 20 PSI	GPM at 30 PSI	GPM at 40 PSI	GPM at 50 PSI	GPM at 60 PSI
800	70	64	53	34		
900	83	79	70	58	42	
1000	96	92	86	78	67	52

9006P-0, 9016P-0

METRIC UNITS

RPM	LPM at 0.7 BAR	LPM at 1.4 BAR	LPM at 2.1 BAR	LPM at 2.8 BAR	LPM at 3.4 BAR	LPM at 4.1 BAR	LPM at 4.8 BAR
450	276	239	196	129			
500	307	291	255	208	142		
550	333	323	295	257	210	137	
600	367	367	354	323	288	249	198

9008P-0, 9018P-0

METRIC UNITS

RPM	LPM at 0.7 BAR	LPM at 1.4 BAR	LPM at 2.1 BAR	LPM at 2.8 BAR	LPM at 3.4 BAR	LPM at 4.1 BAR
800	314	243	200	128		
900	363	299	265	220	161	
1000	327	348	327	296	254	198

9202C and 9202S Series



FEATURES

- ◆ Available in cast iron and 316 stainless steel for extended pump life
- ◆ Pedestal mount, direct drive
- ◆ Port sizes: 1-1/4" NPT inlet, 1" NPT outlet
- ◆ Max. fluid temperature: 140°F/60°C
- ◆ Impeller: Nylon (cast iron standard); polypropylene (stainless standard)
- ◆ Pump shaft rotation: Counter clockwise when looking at the shaft end, 9202S-R is clockwise
- ◆ Pump seals: Viton®/ceramic standard (Life Guard silicon carbide (B) available); Life Guard silicon carbide standard in stainless steel pumps
- ◆ Life Guard seals are the industry standard on OEM equipment
- ◆ Weight: 18 lbs./8.2 kg

UPGRADE OPTIONS

- ◆ Increase dry-run and abrasive resistance with Life Guard Seals. Life Guard seals are the OEM standard
- ◆ Extend pump life with Stainless Steel
 - Chemical corrosion, pump cavitation, and abrasive wear are key factors in pump life
 - 316 Stainless Steel pumps provide superior chemical corrosion resistance, while maintaining material strength to prolong the life against abrasive wear
 - 316 Stainless Steel resists cavitation pitting of pumps, extending the wear life
 - Drop in replacements for cast iron pumps

ORDERING INFORMATION

Model Number	Max GPM	Max LPM	Max PSI	Max BAR	Max RPM	Shaft Output
9202C	103	390	170	11.7	6000	5/8" (15.9 mm) solid shaft
9202S	103	390	170	11.7	6000	5/8" (15.9 mm) stainless steel shaft
9202S-R	103	390	170	11.7	6000	5/8" (15.9 mm) stainless steel shaft
3430-0332	Seal and o-ring repair kit					
3430-0589	Life Guard silicon carbide seal kit					
3430-0592	12 volt clutch kit					

Life Guard silicon carbide seal - Add suffix "B" (i.e.: 9202C-B)

9202C, 9202S, 9202S-R

U.S. UNITS

RPM	10 PSI		20 PSI		40 PSI		60 PSI		80 PSI		100 PSI		120 PSI		140 PSI	
	GPM	HP	GPM	HP	GPM	HP	GPM	HP	GPM	HP	GPM	HP	GPM	HP	GPM	HP
2400	50	1.3	46	1.2												
3600	67	3.7	66	3.7	62	3.5	34	2.6								
4200	75	5.7	75	5.7	75	5.7	66	5.3	44	4.2						
5000	88	9.3	88	9.3	88	9.3	88	9.3	77	8.6	60	7.5	24	6.4		
6000	103	15.6	103	15.6	103	15.6	103	15.6	103	15.6	100	15.5	91	14.8	75	14

9202C, 9202S, 9202S-R

METRIC UNITS

RPM	0.7 BAR		1.4 BAR		2.8 BAR		4.1 BAR		5.5 BAR		6.9 BAR		8.3 BAR		9.7 BAR	
	LPM	HP	LPM	HP	LPM	HP	LPM	HP	LPM	HP	LPM	HP	LPM	HP	LPM	HP
2400	189	1.3	174	1.2												
3600	254	3.7	250	3.7	235	3.5	129	2.6								
4200	284	5.7	284	5.7	284	5.7	250	5.3	167	4.2						
5000	333	9.3	333	9.3	333	9.3	333	9.3	291	8.6	227	7.5	91	6.4		
6000	390	15.6	390	15.6	390	15.6	390	15.6	390	15.6	379	15.5	344	14.8	284	14

9203C and 9203S Series



UPGRADE OPTIONS

- ◆ Increase dry-run and abrasive resistance with Life Guard Seals
 - Life Guard seals are the OEM standard
- ◆ Extend pump life with Stainless Steel
 - Chemical corrosion, pump cavitation, and abrasive wear are key factors in pump life
 - 316 Stainless Steel pumps provide superior chemical corrosion resistance, while maintaining material strength to prolong the life against abrasive wear
 - 316 Stainless Steel resists cavitation pitting of pumps, extending the wear life
 - Drop in replacements for cast iron pumps

FEATURES

- ◆ Available in cast iron and 316 stainless steel for extended pump life
- ◆ Pedestal mount, direct drive
- ◆ Port sizes: 1-1/2" NPT inlet, 1-1/4" NPT outlet
- ◆ 220 x 200 Universal flange available (U)
- ◆ Max. fluid temperature: 140°F/60°C
- ◆ Impeller: Nylon (cast iron standard); polypropylene (stainless standard); GTX available
- ◆ Pump shaft rotation: Counter clockwise when looking at the shaft end; 9203C-R is clockwise
- ◆ Pump seals: Cast Iron models - Viton®/ceramic standard; Life Guard silicon carbide (B) available; Stainless Steel models - Life Guard silicon carbide standard
- ◆ Life Guard seals are the industry standard on OEM equipment
- ◆ Weight: 19 lbs./8.6 kg
- ◆ Flanged connections need universal flange gasket and universal flange clamp

ORDERING INFORMATION

Model Number	Max GPM	Max LPM	Max PSI	Max PSI (BAR)	Max RPM	Shaft Output
9203C †	140	530	170	11.7	6000	5/8" (15.9 mm) solid shaft
9203C-R (CW)	140	530	170	11.7	6000	5/8" (15.9 mm) solid shaft
9203S †	140	530	170	11.7	6000	5/8" (15.9 mm) stainless steel shaft
9203S-R (CW)	140	530	170	11.7	6000	5/8" (15.9 mm) stainless steel shaft
3430-0332	Seal and o-ring repair kit					
3430-0589	Life Guard silicon carbide seal kit					
3430-0592	12 volt clutch kit					

† Universal Flange (220 x 200) - Add Suffix "U" (i.e.: 9203C-U)
 Life Guard silicon carbide seal - Add suffix "B" (i.e.: 9203C-B)

9203C, 9203S, 9203C-R, 9203S-R

U.S. UNITS

RPM	10 PSI		20 PSI		40 PSI		60 PSI		80 PSI		100 PSI		120 PSI		140 PSI	
	GPM	HP	GPM	HP	GPM	HP	GPM	HP	GPM	HP	GPM	HP	GPM	HP	GPM	HP
2400	80	1.9	65	1.8												
3600	105	5.3	105	5.3	92	5.0	50	3.7								
4200	122	8.2	120	7.9	115	7.7	98	7.1	56	5.3						
5000	140	12.6	140	12.6	138	12.6	130	12.2	118	11.6	88	9.9	45	7.2		
5500	140	14.9	140	14.9	138	14.9	135	15.2	130	15.2	118	14.4	90	12.5	60	9.8
6000	140	17.1	140	17.1	140	17.5	140	18.0	135	18.2	132	18	125	18.2	103	16.3

9203C, 9203S, 9203C-R, 9203S-R

METRIC UNITS

RPM	0.7 BAR		1.4 BAR		2.8 BAR		4.1 BAR		5.5 BAR		6.9 BAR		8.3 BAR		9.7 BAR	
	LPM	HP	LPM	HP	LPM	HP	LPM	HP	LPM	HP	LPM	HP	LPM	HP	LPM	HP
2400	303	1.9	246	1.8												
3600	397	5.3	397	5.3	348	5.0	189	3.7								
4200	462	8.2	454	7.9	435	7.7	371	7.1	212	5.3						
5000	530	12.6	530	12.6	522	12.6	492	12.2	447	11.6	333	9.9	170	7.2		
5500	530	14.9	530	14.9	522	14.9	511	15.2	492	15.2	447	14.4	341	12.5	227	9.8
6000	530	17.1	530	17.1	530	17.5	530	18.0	511	18.2	500	18	473	18.2	409	16.3

9205C Series



FEATURES

- ◆ Pedestal mount, direct drive
- ◆ Port sizes: 2" NPT inlet, 1-1/2" NPT outlet
- ◆ Max. fluid temperature: 140°F/60°C
- ◆ Housing: Cast iron
- ◆ Impeller: Nylon
- ◆ Pump shaft rotation: Counter clockwise when looking at the shaft end
- ◆ Pump seals: Viton®/ceramic standard; Life Guard silicon carbide (B) available
- ◆ Life Guard seals are the industry standard on OEM equipment
- ◆ Weight: 47 lbs./21.4 kg

UPGRADE OPTIONS

- ◆ Increase dry-run and abrasive resistance with Life Guard Seals
 - Life Guard seals are the OEM standard

ORDERING INFORMATION

Model Number	Max GPM	Max LPM	Max PSI	Max BAR	Max RPM	Shaft Output
9205C	180	681	196	13.5	4200	7/8" (22.2 mm) solid keyed shaft
3430-0537	Seal and o-ring repair kit					
3430-0646	Life Guard silicon carbide seal kit					
2526-0011	Clutch/single groove					

Life Guard silicon carbide seal - Add suffix "B" (i.e.: 9205C-B)

9205C

U.S. UNITS

RPM	20 PSI		40 PSI		60 PSI		80 PSI		100 PSI		120 PSI		140 PSI		160 PSI	
	GPM	HP	GPM	HP	GPM	HP	GPM	HP	GPM	HP	GPM	HP	GPM	HP	GPM	HP
3000	165	11.4	164	11.7	154	11.6	104	9.5								
3400	175	14.8	175	15.5	173	16.3	168	16.3	127	14.2	43	8.7				
3800	180	18.2	180	18.8	180	19.8	178	21.1	173	21.8	156	20.7	112	17.5		
4200	180	21.9	180	22.0	180	24.0	180	25.3	180	26.9	177	27.9	173	28.1	157	26.4

9205C

METRIC UNITS

RPM	1.4 BAR		2.8 BAR		4.1 BAR		5.5 BAR		6.9 BAR		8.3 BAR		9.7 BAR		11.0 BAR	
	LPM	HP	LPM	HP	LPM	HP	LPM	HP	LPM	HP	LPM	HP	LPM	HP	LPM	HP
3000	625	11.4	621	11.7	583	11.6	394	9.5								
3400	662	14.8	662	15.5	655	16.3	636	16.3	481	14.2	163	8.7				
3800	681	18.2	681	18.8	681	19.8	674	21.1	655	21.8	591	20.7	424	17.5		
4200	681	21.9	681	22.0	681	24.0	681	25.3	681	26.9	670	27.9	655	28.1	594	26.4

9203C-SP and 9203S-SP Series



UPGRADE OPTIONS

- ◆ Increase dry-run and abrasive resistance with Life Guard Seals
 - Life Guard seals are the OEM standard
- ◆ Extend pump life with Stainless Steel
 - Chemical corrosion, pump cavitation, and abrasive wear are key factors in pump life
 - 316 Stainless Steel pumps provide superior chemical corrosion resistance, while maintaining material strength to prolong the life against abrasive wear
 - 316 Stainless Steel resists cavitation pitting of pumps, extending the wear life
 - Drop in replacements for cast iron pumps

FEATURES

- ◆ Available in cast iron and 316 stainless steel for extended pump life
- ◆ Pedestal mount, direct drive
- ◆ Port sizes: 1-1/2" NPT inlet, 1-1/4" NPT outlet (9203C-SP, 9203S-SP); 2" NPT inlet, 2" NPT outlet (9203C-R-SP)
- ◆ Max. fluid temperature: 140°F/60°C
- ◆ Impeller: Nylon (cast iron standard); polypropylene (stainless steel); GTX available
- ◆ Pump shaft rotation: Counter clockwise when looking at the shaft end; 9203C-R-SP is clockwise
- ◆ Pump seals: Cast Iron models - Viton®/ceramic standard; Life Guard silicon carbide (B) available; Stainless Steel models - Life Guard silicon carbide standard
- ◆ Life Guard seals are the industry standard on OEM equipment
- ◆ Weight: 31.7 lbs./14.4 kg - Stainless Steel; 29 lbs./13.2 kg - Cast Iron

ORDERING INFORMATION

Model Number	Max GPM	Max LPM	Max PSI	Max BAR	Max RPM	Shaft Output
9203C-SP	120	454	157	10.8	6000	5/8" (15.9 mm) solid shaft
9203C-R-SP (CW)	140	530	155	10.7	6000	5/8" (15.9 mm) solid shaft
9203S-SP	120	454	157	10.8	6000	5/8" (15.9 mm) stainless steel shaft
3430-0332						Seal and o-ring repair kit
3430-0589						Life Guard silicon carbide seal kit
3430-0480SP						Self priming chamber kit
3430-0592						12 volt clutch kit

Life Guard silicon carbide seal - Add suffix "B" (i.e.: 9203C-SP-B)

PEDESTAL MOUNT, CAST IRON & STAINLESS STEEL, SELF-PRIMING

CENTRIGUAL PUMPS

9203C-SP and 9203S-SP Series

9203C-R-SP

U.S. UNITS

RPM	20 PSI		40 PSI		60 PSI		80 PSI		100 PSI		120 PSI		140 PSI	
	GPM	HP	GPM	HP	GPM	HP	GPM	HP	GPM	HP	GPM	HP	GPM	HP
3600	80	3.8	43	2.9										
4200	102	6.1	76	5.4	38	4								
5000	127	10.5	109	9.8	86	8.7	55	7.2	18	5.4				
5500	135	13.5	125	13.1	110	12.3	83	10.9	57	9.3	21	6.9		
6000	138	15.7	132	15.7	122	15.1	111	14.1	93	13.2	67	12.2	32	9.5

9203C-R-SP

METRIC UNITS

RPM	1.4 BAR		2.8 BAR		4.1 BAR		5.5 BAR		6.9 BAR		8.3 BAR		9.7 BAR	
	LPM	HP	LPM	HP	LPM	HP	LPM	HP	LPM	HP	LPM	HP	LPM	HP
3600	303	3.8	163	2.9										
4200	386	6.1	288	5.4	144	4								
5000	481	10.5	413	9.8	326	8.7	208	7.2	68	5.4				
5500	511	13.5	473	13.1	416	12.3	314	10.9	216	9.3	79	6.9		
6000	522	15.7	500	15.7	462	15.1	420	14.1	352	13.2	254	12.2	121	9.5

9203C-SP, 9203S-SP

U.S. UNITS

RPM	20 PSI		40 PSI		60 PSI		80 PSI		100 PSI		120 PSI		140 PSI	
	GPM	HP	GPM	HP	GPM	HP	GPM	HP	GPM	HP	GPM	HP	GPM	HP
3600	101	4.2	60	3.4										
4200	118	6.7	97	6.1	54	4.7								
5000	120	10.1	119	10.3	110	10.1	78	8.7	25	5.8				
5500	120	12.1	119	12.7	116	13.2	110	12.8	79	11.0	29	7.6		
6000	120	14.3	119	15.0	116	15.7	114	16.0	110	16.0	82	14.0	40	10.6

9203C-SP, 9203S-SP

METRIC UNITS

RPM	1.4 BAR		2.8 BAR		4.1 BAR		5.5 BAR		6.9 BAR		8.3 BAR		9.7 BAR	
	LPM	HP	LPM	HP	LPM	HP	LPM	HP	LPM	HP	LPM	HP	LPM	HP
3600	382	4.2	227	3.4										
4200	447	6.7	367	6.1	204	4.7								
5000	458	10.1	450	10.3	416	10.1	295	8.7	95	5.8				
5500	458	12.1	450	12.7	439	13.2	416	12.8	299	11.0	110	7.6		
6000	458	14.3	450	15.0	439	15.7	432	16.0	416	16.0	310	14.0	157	10.6

9205C-SP Series



FEATURES

- ◆ Pedestal mount, direct drive
- ◆ Port sizes:
2" NPT inlet, 2" NPT outlet (9205C-SP)
2" BSP inlet, 2" BSP outlet (9205C-BSP)
- ◆ Max. fluid temperature: 140°F/60°C
- ◆ Housing: Cast iron
- ◆ Impeller: Nylon
- ◆ Pump shaft rotation: Counter clockwise when looking at the shaft end
- ◆ Pump seals: Viton®/ceramic standard; Life Guard silicon carbide (B) available
- ◆ Life Guard seals are the industry standard on OEM equipment
- ◆ Weight: 48 lbs./21.8 kg

UPGRADE OPTIONS

- ◆ Increase dry-run and abrasive resistance with Life Guard Seals
 - Life Guard seals are the OEM standard

ORDERING INFORMATION

Model Number	Max GPM	Max LPM	Max PSI	Max BAR	Max RPM	Shaft Output
9205C-SP	160	606	145	10.0	3800	7/8" (22.2 mm) solid keyed shaft
9205C-BSP	160	606	145	10.0	3800	7/8" (22.2 mm) solid keyed shaft
3430-0537	Seal and o-ring repair kit					
3430-0646	Life Guard silicon carbide seal kit					
2526-0011	Clutch/single groove					

Life Guard silicon carbide seal - Add suffix "B" (i.e.: 9205C-SP-B)

9205C-SP, 9205C-BSP

U.S. UNITS

RPM	GPM at 40 PSI	GPM at 50 PSI	GPM at 60 PSI	GPM at 70 PSI	GPM at 80 PSI	GPM at 90 PSI	GPM at 100 PSI	GPM at 110 PSI	GPM at 120 PSI	GPM at 130 PSI	GPM at 140 PSI
3400	155	154	153	150	131	110	84	35			
3600	158	157	156	155	153	137	114	88	58		
3800	160	159	158	157	156	155	142	123	102	74	28

9205C-SP, 9205C-BSP

METRIC UNITS

RPM	LPM at 2.8 BAR	LPM at 3.4 BAR	LPM at 4.1 BAR	LPM at 4.8 BAR	LPM at 5.5 BAR	LPM at 6.2 BAR	LPM at 6.9 BAR	LPM at 7.6 BAR	LPM at 8.3 BAR	LPM at 8.9 BAR	LPM at 9.7 BAR
3400	587	583	579	568	496	416	318	132			
3600	598	594	591	587	579	518	432	333	220		
3800	606	602	598	594	591	587	538	466	383	280	106

9206C and 9206S Series



UPGRADE OPTIONS

- ◆ Increase dry-run and abrasive resistance with Life Guard Seals
 - Life Guard seals are the OEM standard
- ◆ Extend pump life with Stainless Steel
 - Chemical corrosion, pump cavitation, and abrasive wear are key factors in pump life
 - 316 Stainless Steel pumps provide superior chemical corrosion resistance, while maintaining material strength to prolong the life against abrasive wear
 - 316 Stainless Steel resists cavitation pitting of pumps, extending the wear life
 - Drop in replacements for cast iron pumps

FEATURES

- ◆ Available in cast iron and 316 stainless steel for extended pump life
- ◆ Pedestal mount, direct drive
- ◆ Port sizes: 2" NPT inlet, 1-1/2" NPT outlet
- ◆ 220 x 220 (U) and 300 x 220 (-3U models) universal flange available
- ◆ Max. fluid temperature: 140°F/60°C
- ◆ Impeller: Nylon (standard in cast iron); polypropylene (standard in stainless steel); GTX available
- ◆ Pump shaft rotation: Counter clockwise when looking at the shaft end
- ◆ Pump seals: Cast Iron models – Viton®/ceramic standard; Life Guard silicon carbide (B) available; Stainless Steel models – Life Guard silicon carbide standard
- ◆ Life Guard seals are the industry standard on OEM equipment
- ◆ Weight: 23 lbs./10.5 kg
- ◆ Flanged connections need universal flange gasket and universal flange clamp

ORDERING INFORMATION

Model Number	Max GPM	Max LPM	Max PSI	Max BAR	Max RPM	Shaft Output
9206C*	225	852	80	5.5	4200	5/8" (15.9 mm) solid shaft
9206S	225	852	80	5.5	4200	5/8" (15.9 mm) stainless steel shaft
3430-0332	Seal and o-ring repair kit					
3430-0589	Life Guard silicon carbide seal kit					

*Universal Flange (220 x 220) - Add Suffix "U" (i.e.: 9206C-U),
 Universal Flange (300 x 220) - Add Suffix "3U" (i.e.: 9206C-3U),
 Life Guard silicon carbide seal - Add suffix "B" (i.e.: 9206C-B)

9206C, 9206S, 9206C-U, 9206S-3U

U.S. UNITS

RPM	10 PSI		20 PSI		30 PSI		40 PSI		50 PSI		60 PSI		70 PSI		80 PSI	
	GPM	HP	GPM	HP	GPM	HP	GPM	HP	GPM	HP	GPM	HP	GPM	HP	GPM	HP
2400	171	2.3	114	2.0												
3600	225	7.0	225	7.1	225	7.5	196	7.3	143	6.1						
4200	225	9.2	225	9.4	225	10.7	225	11.0	225	11.3	202	10.9	158	9.5	80	6.4

9206C, 9206S, 9206C-U, 9206S-3U

METRIC UNITS

RPM	0.7 BAR		1.4 BAR		2.1 BAR		2.8 BAR		3.4 BAR		4.1 BAR		4.8 BAR		5.5 BAR	
	LPM	HP	LPM	HP	LPM	HP	LPM	HP	LPM	HP	LPM	HP	LPM	HP	LPM	HP
2400	647	2.3	432	2.0												
3600	852	7.0	852	7.1	852	7.5	742	7.3	541	6.1						
4200	852	9.2	852	9.4	852	10.7	852	11.0	852	11.3	765	10.9	598	9.5	303	6.4

9203P-S Series

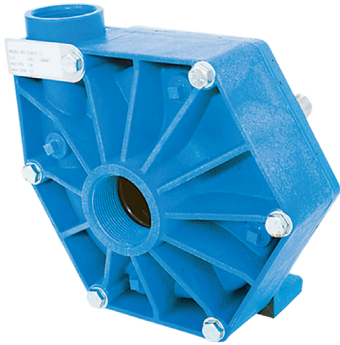

FEATURES

- ◆ Pedestal mount
- ◆ For belt and pulley drive
- ◆ Port sizes: 1-1/2" NPT inlet, 1-1/4" NPT outlet
- ◆ Max. fluid temperature: 140°F/60°C
- ◆ Housing: Polypropylene
- ◆ Impeller: Polypropylene
- ◆ Pump shaft rotation: Counter clockwise 9203P-S, when looking at the shaft end; 9203P-SR is clockwise
- ◆ Pump seals: Viton®/ceramic standard; Life Guard silicon carbide (B) available
- ◆ Life Guard seals are the industry standard on OEM equipment
- ◆ Weight: 14 lbs./6.4 kg

UPGRADE OPTIONS

- ◆ Increase abrasive resistance with Life Guard Seals
 - Life Guard seals are the OEM standard

ORDERING INFORMATION

Model Number	Max GPM	Max LPM	Max PSI	Max BAR	Max RPM	Shaft Output
9203P-S	100	379	82	5.7	4200	7/8" (22.2 mm) solid keyed stainless steel shaft
9203P-SR	100	379	82	5.7	4200	7/8" (22.2 mm) solid keyed stainless steel shaft
3430-0333	Seal and o-ring repair kit					
3430-0590	Life Guard silicon carbide seal kit					
2526-0011	12 volt clutch kit					

Life Guard silicon carbide seal - Add suffix "B" (i.e.: 9203P-S-B)

9203P-S, 9203P-SR

U.S. UNITS

RPM	10 PSI		20 PSI		30 PSI		40 PSI		50 PSI		60 PSI		70 PSI		80 PSI	
	GPM	HP	GPM	HP	GPM	HP	GPM	HP	GPM	HP	GPM	HP	GPM	HP	GPM	HP
2400	55	1.5	49	1.4	32	1.1										
3600	89	4.4	87	4.3	81	4.1	71	3.9	58	3.6	37	3.1				
4200	100	6.7	100	6.6	97	6.5	90	6.3	82	6.0	71	5.7	60	5.2	39	4.4

9203P-S, 9203P-SR

METRIC UNITS

RPM	0.7 BAR		1.4 BAR		2.1 BAR		2.8 BAR		3.4 BAR		4.1 BAR		4.8 BAR		5.5 BAR	
	LPM	HP	LPM	HP	LPM	HP	LPM	HP	LPM	HP	LPM	HP	LPM	HP	LPM	HP
2400	208	1.5	185	1.4	121	1.1										
3600	337	4.4	329	4.3	307	4.1	269	3.9	220	3.6	140	3.1				
4200	379	6.7	379	6.6	367	6.5	341	6.3	310	6.0	269	5.7	227	5.2	148	4.4

9213P Series



FEATURES

- ◆ Mounts clockwise rotation (when looking at the shaft end) – for direct mount to gasoline engines
- ◆ Shaft: 3/4" (19 mm) hollow, 416 stainless steel
- ◆ Port size: 1-1/2" NPT inlet, 1-1/4" NPT outlet
- ◆ Max. fluid temperature: 140°F/60°C
- ◆ Housing: Polypropylene
- ◆ Impeller: Polypropylene
- ◆ Flange bolt pattern for 5 HP gas engine
- ◆ Pump seals: Viton®/ceramic standard; Life Guard silicon carbide (B) available
- ◆ Life Guard seals are the industry standard on OEM equipment
- ◆ Weight: 19 lbs./8.6 kg

UPGRADE OPTIONS

- ◆ Increase abrasive resistance with Life Guard Seals
 - Life Guard seals are the OEM standard

ORDERING INFORMATION

Model Number	Max GPM	Max LPM	Max PSI	Max BAR	Max RPM	PTO Output
9213P	91	344	65	4.5	3600	3/4" hollow keyed stainless steel shaft for direct coupling to 5HP engine
3430-0333						Seal and o-ring repair kit
3430-0590						Life Guard silicon carbide seal kit

Life Guard silicon carbide seal - Add suffix "B" (i.e.: 9213P-B)

9213P – BASED ON 5.5 HP HONDA® ENGINE

U.S. UNITS

GPM at 0 PSI	GPM at 10 PSI	GPM at 20 PSI	GPM at 30 PSI	GPM at 40 PSI	GPM at 50 PSI	GPM at 60 PSI
92	91	88	81	70	58	42

9213P – BASED ON 5.5 HP HONDA ENGINE

METRIC UNITS

LPM at 0.0 BAR	LPM at 0.7 BAR	LPM at 1.4 BAR	LPM at 2.1 BAR	LPM at 2.8 BAR	LPM at 3.4 BAR	LPM at 4.1 BAR
348	344	333	307	265	220	159

PEDESTAL MOUNT, CLUTCH-DRIVEN, CAST IRON & STAINLESS STEEL CENTRIGUAL PUMPS

9262C-C Series



UPGRADE OPTIONS

- ◆ Increase dry-run and abrasive resistance with Life Guard Seals
 - Life Guard seals are the OEM standard
- ◆ Extend pump life with Stainless Steel
 - Chemical corrosion, pump cavitation, and abrasive wear are key factors in pump life
 - 316 Stainless Steel pumps provide superior chemical corrosion resistance, while maintaining material strength to prolong the life against abrasive wear
 - 316 Stainless Steel resists cavitation pitting of pumps, extending the wear life
 - Drop in replacements for cast iron pumps

FEATURES

- ◆ Pedestal mount with DC clutch drive
- ◆ Double "A" groove pulley (5 7/125 mm diameter)
- ◆ Port sizes: 1-1/4" NPT inlet, 1" NPT outlet
- ◆ Max. fluid temperature: 140°F/60°C
- ◆ Available in cast iron and 316 stainless steel for extended pump life
- ◆ Impeller: Nylon (standard in cast iron); polypropylene (standard in stainless steel); GTX available
- ◆ Pump shaft rotation: Counter clockwise when looking at the shaft end; Clockwise for -CR models
- ◆ Pump seals: Cast Iron models - Viton®/ceramic standard; Life Guard silicon carbide (B) available; Stainless Steel models (Life Guard silicon carbide standard)
 - Life Guard seals are the industry standard on OEM equipment
- ◆ 3.75 Amp draw (45 watts at 12 volts)
- ◆ Weight: 23 lbs./10.5 kg

ORDER INFORMATION

Model Number	Max GPM	Max LPM	Max PSI	Max PSI	Max RPM	Rotation
9262C-C	88	333	114	7.9	5000	CCW*
9262S-CR	145	549	114	7.9	5000	CW*
3430-0332	Seal and o-ring repair kit					
3430-0589	Life Guard silicon carbide seal kit					

Life Guard silicon carbide seal - Add suffix "B" (i.e.: 9262C-CB)

*CCW (counterclockwise) CW (clockwise) are determined when looking at the shaft end.

PEDESTAL MOUNT, CLUTCH-DRIVEN, CAST IRON & STAINLESS STEEL CENTRIGUAL PUMPS

9262C-C Series

9262C-C

U.S. UNITS

RPM	10 PSI		20 PSI		40 PSI		60 PSI		80 PSI		100 PSI	
	GPM	HP	GPM	HP	GPM	HP	GPM	HP	GPM	HP	GPM	HP
2400	50	1.3	46	1.2								
3600	67	3.7	66	3.7	62	3.5	25	2.8				
4200	75	5.7	75	5.7	75	5.7	66	5.3	40	4.6		
5000	88	9.3	88	9.3	88	9.3	88	9.3	77	8.6	60	7.5

9262C-C

METRIC UNITS

RPM	0.7 BAR		1.4 BAR		2.8 BAR		4.1 BAR		5.5 BAR		6.9 BAR	
	LPM	HP	LPM	HP	LPM	HP	LPM	HP	LPM	HP	LPM	HP
2400	189	1.3	174	1.2								
3600	254	3.7	250	3.7	235	3.5	95	2.8				
4200	284	5.7	284	5.7	284	5.7	250	5.3	151	4.6		
5000	333	9.3	333	9.3	333	9.3	333	9.3	291	8.6	227	7.5

9262S-CR

U.S. UNITS

RPM	10 PSI		20 PSI		40 PSI		60 PSI		80 PSI		100 PSI	
	GPM	HP	GPM	HP	GPM	HP	GPM	HP	GPM	HP	GPM	HP
2400	73	1.4	55	1.2								
3600	112	4.5	109	4.5	86	4.0	25	2.8				
4200	128	7.1	127	7.1	116	6.8	92	6.1	40	4.6		
5000	145	11.8	145	11.8	143	11.7	133	11.3	115	10.4	86	9.1

9262S-CR

METRIC UNITS

RPM	0.7 BAR		1.4 BAR		2.8 BAR		4.1 BAR		5.5 BAR		6.9 BAR	
	LPM	HP	LPM	HP	LPM	HP	LPM	HP	LPM	HP	LPM	HP
2400	276	1.4	208	1.2								
3600	424	4.5	413	4.5	326	4.0	95	2.8				
4200	484	7.1	481	7.1	439	6.8	348	6.1	151	4.6		
5000	549	11.8	549	11.8	541	11.7	503	11.3	435	10.4	326	9.1

PEDESTAL MOUNT, CLUTCH-DRIVEN, CAST IRON & STAINLESS STEEL, SELF-PRIMING

9263C-SP and 9263S-SP Series



UPGRADE OPTIONS

- ◆ Increase dry-run and abrasive resistance with Life Guard Seals
 - Life Guard seals are the OEM standard
- ◆ Extend pump life with Stainless Steel
 - Chemical corrosion, pump cavitation, and abrasive wear are key factors in pump life
 - 316 Stainless Steel pumps provide superior chemical corrosion resistance, while maintaining material strength to prolong the life against abrasive wear
 - 316 Stainless Steel resists cavitation pitting of pumps, extending the wear life
 - Drop in replacements for cast iron pumps

FEATURES

- ◆ Available in cast iron and 316 stainless steel for extended pump life
- ◆ Double "A" groove pulley (5"/125 mm diameter)
- ◆ Pedestal mount with DC clutch drive
- ◆ Max fluid temperature: 140° F/60° C
- ◆ Impeller: Nylon (standard in cast iron); polypropylene (standard in stainless steel); GTX available
- ◆ Pump seals: Cast Iron models - Viton®/ceramic standard; Life Guard silicon carbide (B) available; Stainless Steel models (Life Guard silicon carbide standard)
- ◆ Life Guard seals are the industry standard on OEM equipment
- ◆ 3.75 Amp draw (45 watts at 12 volts)

ORDERING INFORMATION

Model Number	Max GPM	Max LPM	Max PSI	Max BAR	Max RPM	Rotation	Port Sizes
9263C-CR-SP	127	481	110	7.6	5000	CW*	2" NPT inlet x 2" NPT outlet
9263C-CR-SP-B	127	481	110	7.6	5000	CW*	2" NPT inlet x 2" NPT outlet
9263C-C-SP	120	454	110	7.6	5000	CCW*	1-1/2" NPT inlet x 1-1/4" NPT outlet
9263S-C-SP	120	454	110	7.6	5000	CCW*	1-1/2" NPT inlet x 1-1/4" NPT outlet
3430-0332	Seal and o-ring repair kit						
3430-0589	Life Guard silicon carbide seal kit						

Life Guard silicon carbide seal - Add suffix "B" (i.e.: 9263-CR-SP-B) *CCW (counterclockwise) CW (clockwise) are determined when looking at the shaft end.

9263C-CR-SP, 9263C-CR-SP-B

U.S. UNITS

RPM	20 PSI		30 PSI		40 PSI		50 PSI		60 PSI		70 PSI		80 PSI		90 PSI		100 PSI		
	GPM	HP	GPM	HP	GPM	HP	GPM	HP	GPM	HP	GPM	HP	GPM	HP	GPM	HP	GPM	HP	
3600	80	3.8	64	3.4	43	2.9	17	2.6											
4200	102	6.1	90	5.8	76	5.4	59	4.7	38	4.0	16	3.7							
5000	127	10.5	119	10.2	109	9.8	99	9.3	86	8.7	70	7.9	55	7.2	37	6.2	18	5.4	

9263C-CR-SP, 9263C-CR-SP-B

METRIC UNITS

RPM	1.4 BAR		2.1 BAR		2.8 BAR		3.4 BAR		4.1 BAR		4.8 BAR		5.5 BAR		6.2 BAR		6.9 BAR		
	LPM	HP	LPM	HP	LPM	HP	LPM	HP	LPM	HP	LPM	HP	LPM	HP	LPM	HP	LPM	HP	
3600	303	3.8	242	3.4	163	2.9	64	2.6											
4200	386	6.1	341	5.8	288	5.4	223	4.7	144	4.0	61	3.7							
5000	481	10.5	450	10.2	413	9.8	375	9.3	326	8.7	265	7.9	208	7.2	140	6.2	68	5.4	

9263C-C-SP, 9263S-C-SP

U.S. UNITS

RPM	20 PSI		30 PSI		40 PSI		50 PSI		60 PSI		70 PSI		80 PSI		90 PSI		100 PSI		
	GPM	HP	GPM	HP	GPM	HP	GPM	HP	GPM	HP	GPM	HP	GPM	HP	GPM	HP	GPM	HP	
3600	101	4.2	84	3.9	60	3.4	25	2.6											
4200	118	6.7	112	6.7	97	6.1	79	5.5	54	4.7	23	4.0							
5000	120	10.1	120	10.3	119	10.3	117	10.2	110	10.1	96	9.6	78	8.7	52	7.2	25	5.8	

9263C-C-SP, 9263S-C-SP

METRIC UNITS

RPM	1.4 BAR		2.1 BAR		2.8 BAR		3.4 BAR		4.1 BAR		4.8 BAR		5.5 BAR		6.2 BAR		6.9 BAR		
	LPM	HP	LPM	HP	LPM	HP	LPM	HP	LPM	HP	LPM	HP	LPM	HP	LPM	HP	LPM	HP	
3600	382	4.2	318	3.9	227	3.4	95	2.6											
4200	447	6.7	424	6.7	367	6.1	299	5.5	204	4.7	87	4.0							
5000	454	10.1	454	10.3	450	10.3	443	10.2	416	10.1	363	9.6	295	8.7	197	7.2	95	5.8	

PEDESTAL MOUNT, CLUTCH-DRIVEN, CAST IRON & STAINLESS STEEL CENTRIFUGAL PUMPS

9263C-C and 9263S-C Series



UPGRADE OPTIONS

- ◆ Increase dry-run and abrasive resistance with Life Guard Seals
 - Life Guard seals are the OEM standard
- ◆ Extend pump life with Stainless Steel
 - Chemical corrosion, pump cavitation, and abrasive wear are key factors in pump life
 - 316 Stainless Steel pumps provide superior chemical corrosion resistance, while maintaining material strength to prolong the life against abrasive wear
 - 316 Stainless Steel resists cavitation pitting of pumps, extending the wear life
 - Drop in replacements for cast iron pumps

FEATURES

- ◆ Available in cast iron and 316 stainless steel for extended pump life
- ◆ Pedestal mount with DC clutch drive
- ◆ Double "A" groove pulley (5"/125 mm diameter)
- ◆ Port sizes: 1-1/2" NPT inlet, 1-1/4" NPT outlet (BSP available on 9263C)
- ◆ 220 x 200 universal flange available (U)
- ◆ Max. fluid temperature: 140°F/60°C
- ◆ Available in cast iron and 316 stainless steel for extended pump life
- ◆ Pedestal mount with DC clutch drive
- ◆ Double "A" groove pulley (5"/125 mm diameter)
- ◆ Port sizes: 1-1/2" NPT inlet, 1-1/4" NPT outlet (BSP available on 9263C)
- ◆ 220 x 200 universal flange available (U)
- ◆ Max. fluid temperature: 140°F/60°C
- ◆ Impeller: Nylon (standard in cast iron); polypropylene (standard in stainless steel); GTX available
- ◆ Pump seals: Cast Iron models - Viton®/ceramic standard; Life Guard silicon carbide (B) available; Stainless Steel models - Life Guard silicon carbide standard
- ◆ Life Guard seals are the industry standard on OEM equipment
- ◆ 3.75 Amp draw (45 watts at 12 volts)
- ◆ Weight: 23 lbs./10.5 kg
- ◆ Flanged connections need universal flange gasket and universal flange clamp

ORDERING INFORMATION

Model Number	Max GPM	Max LPM	Max PSI	Max BAR	Max RPM	Rotation
9263C-C †(BSP Version - 9263C-BT)	140	530	114	7.9	5000	CCW*
9263C-CR	140	530	114	7.9	5000	CW*
9263S-C †	140	530	114	7.9	5000	CCW*
9263S-CR	140	530	114	7.9	5000	CW*
3430-0332	Seal and o-ring repair kit					
3430-0589	Life Guard silicon carbide seal kit					

† Universal Flange (220 x 200) - Add Suffix "U" (i.e.: 9263C-C-U) *CCW (counterclockwise) CW (clockwise) are determined when looking at the shaft end.
Life Guard silicon carbide seal - Add suffix "B" (i.e.: 9263C-CB)

9263C-C, 9263S-C, 9263C-CR, 9263S-CR, 9263C-C-U, 9263S-C-U

U.S. UNITS

RPM	10 PSI		20 PSI		40 PSI		60 PSI		80 PSI		100 PSI	
	GPM	HP	GPM	HP	GPM	HP	GPM	HP	GPM	HP	GPM	HP
2400	80	1.9	65	1.8								
3600	105	5.3	105	5.3	92	5.0	50	3.7				
4200	122	8.2	120	7.9	115	7.7	98	7.1	56	5.3		
5000	140	12.6	140	12.6	138	12.6	130	12.2	118	11.6	88	9.9

9263C-C, 9263S-C, 9263C-CR, 9263S-CR, 9263C-C-U, 9263S-C-U

METRIC UNITS

RPM	0.7 BAR		1.4 BAR		2.8 BAR		4.1 BAR		5.5 BAR		6.9 BAR	
	LPM	HP	LPM	HP	LPM	HP	LPM	HP	LPM	HP	LPM	HP
2400	303	1.9	246	1.8								
3600	397	5.3	397	5.3	348	5.0	189	3.7				
4200	462	8.2	454	7.9	435	7.7	371	7.1	212	5.3		
5000	530	12.6	530	12.6	522	12.6	492	12.2	447	11.6	333	9.9

93HPS Series

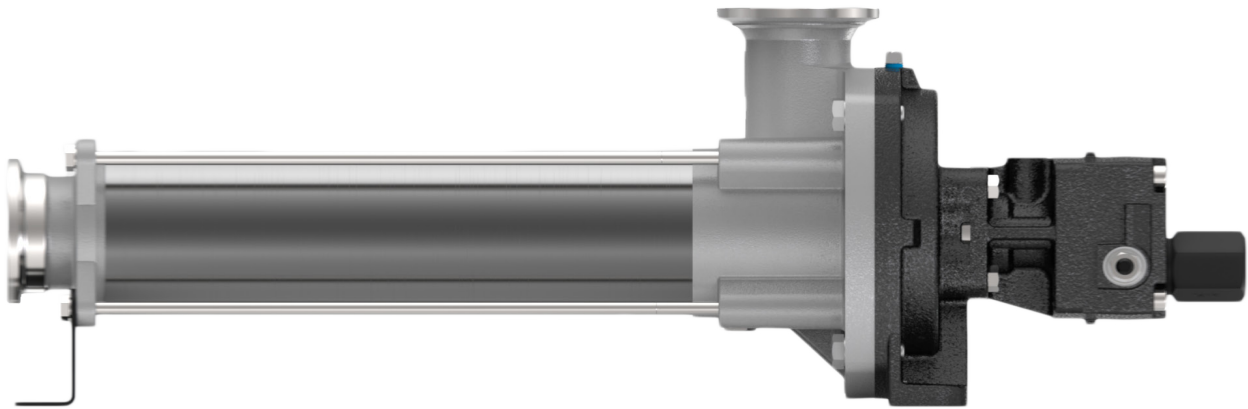

FEATURES

- ◆ Versatile multistage centrifugal pump with dry run protection and priming assistance.
- ◆ Proven SignaSeal staging system utilizes ceramic wear surfaces for superior abrasive handling.
- ◆ Stainless steel and engineered polymer components offer corrosion and abrasion resistance.
- ◆ Extended service life results in reduced maintenance and total cost of ownership.
- ◆ Prevent dry run failures with Cobalt Series wet seal.
- ◆ Max RPM: 93HPS114-M05 = 58 GPM (220 LPM); 93HPS114-M05-SP = 47 GPM(178 LPM).
- ◆ Ports: 93HPS114-M05: 2" Universal Flange Inlet, 3/4 NPT (female) outlet. 93HPS114-M05-SP: 2" Universal Flange Inlet, 2" Universal Flange Outlet.
- ◆ Hydraulic Ports: SAE-8,SAE-10.
- ◆ Dry Weight: 43 lbs (19.5 kg)
- ◆ Mounting Bolts: M10 or 3/8"

ORDERING INFORMATION

Model Number	Max GPM	Max LPM	INLET MAX PSI (BAR)	OUTLET MAX PSI (BAR)	MAX FLOW RATE GPM (LPM)	MAX PRESSURE (BAR)
93HPS114-M05	7	26	2500 (172)	100 (6.9)	58 (220)	200 (13.7)
93HPS114-M05Y*	7	26	2500 (172)	100 (6.9)	58 (220)	200 (13.7)
93HPS114-M05-SP	7	26	2500 (172)	100 (6.9)	47 (178)	200 (13.7)

* Model includes case drain hydraulic motor and speed sensor.

HYDRAULICALLY DRIVEN COBALT PUMPS

CENTRIGUAL PUMPS

93HPS Series

MODELS 93HPS114-M05, 93HPS114-M05Y

U.S. UNITS

Hyd Flow GPM	GPM at 10 PSI	GPM at 20 PSI	GPM at 30 PSI	GPM at 40 PSI	GPM at 50 PSI	GPM at 60 PSI	GPM at 70 PSI	GPM at 80 PSI	GPM at 90 PSI	GPM at 100 PSI	GPM at 110 PSI	GPM at 120 PSI	GPM at 130 PSI	GPM at 140 PSI
4	34	32	29	26	22	16								
5	42	41	39	36	34	32	28	24	20	14				
6	50	49	48	46	44	42	39	37	34	32	28	25	19	10
7	57	55	53	52	50	48	46	45	42	40	38	36	33	30

MAX GPM = 57, MAX PSI = 200

METRIC UNITS

Hyd Flow LPM	LPM at 0.7 BAR	LPM at 1.4 BAR	LPM at 2.1 BAR	LPM at 2.8 BAR	LPM at 3.4 BAR	LPM at 4.1 BAR	LPM at 4.8 BAR	LPM at 5.5 BAR	LPM at 6.2 BAR	LPM at 6.9 BAR	LPM at 7.6 BAR	LPM at 8.3 BAR	LPM at 9.0 BAR	LPM at 9.7 BAR
15.1	129	121	110	98	83	61								
18.9	159	155	148	136	129	121	106	91	76	53				
22.7	189	185	182	174	167	159	148	140	129	121	106	95	72	38
26.5	216	208	201	197	189	182	174	170	159	151	144	136	125	114

MODEL 93HPS114-M05-SP

U.S. UNITS

Hyd Flow GPM	GPM at 10 PSI	GPM at 20 PSI	GPM at 30 PSI	GPM at 40 PSI	GPM at 50 PSI	GPM at 60 PSI	GPM at 70 PSI	GPM at 80 PSI	GPM at 90 PSI	GPM at 100 PSI	GPM at 110 PSI	GPM at 120 PSI	GPM at 130 PSI	GPM at 140 PSI
5	37	35	33	31	29	26	23	20	16	11	5			
6	42	41	39	38	36	34	32	29	27	23	20	17	13	8
7	47	46	44	43	41	40	38	36	34	32	29	27	24	21

MAX GPM = 57, MAX PSI = 200

METRIC UNITS

Hyd Flow LPM	LPM at 0.7 BAR	LPM at 1.4 BAR	LPM at 2.1 BAR	LPM at 2.8 BAR	LPM at 3.4 BAR	LPM at 4.1 BAR	LPM at 4.8 BAR	LPM at 5.5 BAR	LPM at 6.2 BAR	LPM at 6.9 BAR	LPM at 7.6 BAR	LPM at 8.3 BAR	LPM at 9.0 BAR	LPM at 9.7 BAR
18	133	126	119	111	101	90	78	65	48	28	9			
22	158	153	147	141	134	127	119	110	98	86	73	59	45	28
26	178	173	168	162	157	151	144	136	130	122	113	104	93	80

9302C and 9302S Series

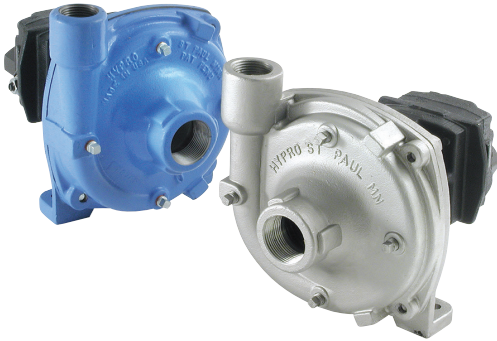

UPGRADE OPTIONS

- ◆ Increase dry-run and abrasive resistance with Life Guard Seals
 - Life Guard seals are the OEM standard
- ◆ Extend pump life with Stainless Steel
 - Chemical corrosion, pump cavitation, and abrasive wear are key factors in pump life
 - 316 Stainless Steel pumps provide superior chemical corrosion resistance, while maintaining material strength to prolong the life against abrasive wear
 - 316 Stainless Steel resists cavitation pitting of pumps, extending the wear life
 - Drop in replacements for cast iron pumps

FEATURES

- ◆ Available in cast iron and 316 stainless steel for extended pump life
- ◆ Hydraulic motor drive (for open center, closed center and load-sensing systems)
- ◆ Port sizes: 1-1/4" NPT inlet, 1" NPT outlet
- ◆ Max. fluid temperature: 140°F/60°C
- ◆ Impeller: Cast Iron models – Nylon; Stainless Steel models – Polypropylene
- ◆ Motor: internal gear gerotor
- ◆ Hydraulic ports: 1/2" NPT inlet, 3/4" NPT outlet-HM Series
- ◆ Hydraulic ports on GM1 Series: 3/4" 16 UNF #8 SAE
- ◆ Pump seals: Cast Iron models – Viton®/ceramic standard; Life Guard silicon carbide (B) available; Stainless Steel models (Life Guard silicon carbide standard)
- ◆ Life Guard seals are the industry standard on OEM equipment
- ◆ Hydraulic motor seal: double-lip Teflon®
- ◆ Max. motor psi: 3000 (bar: 207)
- ◆ Weight: 26 lbs./11.8 kg

ORDERING INFORMATION

Model Number	Max GPM	Max LPM	Max PSI	Max BAR	Max Hyd. GPM	Max Hyd. LPM	Hydraulic Selection System
9302CT-GM1	63	238	90	6.2	3	11.4	Open/Closed
9302C-HM1C	72	273	150	10.3	13	49.2	Open/Closed
9302C-HM2C	65	246	96	6.6	6	22.7	Open/Closed
9302C-HM4C	72	273	120	8.3	7	26.5	Open/Closed
9302ST-GM1	63	238	90	6.2	3	11.4	Open/Closed
9302S-HM1C	72	273	150	10.3	13	49.2	Open/Closed
9302S-HM2C	65	246	96	6.6	6	22.7	Open/Closed
9302S-HM4C	72	273	120	8.3	7	26.5	Open/Closed
3430-0332	Seal and o-ring repair kit						
3430-0589	Life Guard silicon carbide seal kit						

Life Guard silicon carbide seal - Add suffix "B" (i.e.: 9302CT-GM1-B)

9302C and 9302S Series

9302CT-GM1, 9302ST-GM1

U.S. UNITS

Hyd. Flow GPM	GPM at 10 PSI	GPM at 20 PSI	GPM at 30 PSI	GPM at 40 PSI	GPM at 50 PSI	GPM at 60 PSI	GPM at 70 PSI	GPM at 80 PSI	GPM at 90 PSI
2.0	51	48	39	21					
2.5	60	59	56	48	37	23			
3.0	63	63	62	61	58	50	39	25	0

9302CT-GM1, 9302ST-GM1

METRIC UNITS

Hyd. Flow LPM	LPM at 0.7 BAR	LPM at 1.4 BAR	LPM at 2.1 BAR	LPM at 2.8 BAR	LPM at 3.5 BAR	LPM at 4.2 BAR	LPM at 4.9 BAR	LPM at 5.6 BAR	LPM at 6.3 BAR
7.6	193	182	148	79					
9.5	227	223	212	182	140	87			
11.4	238	238	235	231	220	189	148	95	0

9302C-HM1C, 9302S-HM1C

U.S. UNITS

Hyd. Flow GPM	GPM at 40 PSI	GPM at 50 PSI	GPM at 60 PSI	GPM at 70 PSI	GPM at 80 PSI	GPM at 90 PSI	GPM at 100 PSI	GPM at 110 PSI	GPM at 120 PSI	GPM at 130 PSI	GPM at 140 PSI
11	72	72	71	65	56	45	29				
12	72	72	72	72	70	63	53	40			
13	72	72	72	72	72	71	68	63	56	48	35

9302C-HM1C, 9302S-HM1C

METRIC UNITS

Hyd. Flow LPM	LPM at 2.8 BAR	LPM at 3.4 BAR	LPM at 4.1 BAR	LPM at 4.8 BAR	LPM at 5.5 BAR	LPM at 6.2 BAR	LPM at 6.9 BAR	LPM at 7.6 BAR	LPM at 8.3 BAR	LPM at 9.0 BAR	LPM at 9.7 BAR
41.6	273	273	269	246	212	170	110				
45.4	273	273	273	273	265	238	201	151			
49.2	273	273	273	273	273	269	257	238	212	182	132

9302C-HM2C, 9302S-HM2C

U.S. UNITS

Hyd. Flow GPM	GPM at 10 PSI	GPM at 20 PSI	GPM at 30 PSI	GPM at 40 PSI	GPM at 50 PSI	GPM at 60 PSI	GPM at 70 PSI	GPM at 80 PSI	GPM at 90 PSI
4	54	49	42	34	19				
5	59	57	50	42	34	25	11		
6	64	63	60	52	44	36	27	18	9

9302C-HM2C, 9302S-HM2C

METRIC UNITS

Hyd. Flow LPM	LPM at 0.7 BAR	LPM at 1.4 BAR	LPM at 2.1 BAR	LPM at 2.8 BAR	LPM at 3.4 BAR	LPM at 4.1 BAR	LPM at 4.8 BAR	LPM at 5.5 BAR	LPM at 6.2 BAR
15.1	204	185	159	129	72				
18.9	223	216	189	159	129	95	42		
22.7	244	238	227	197	167	136	102	68	34

9302C-HM4C, 9302S-HM4C

U.S. UNITS

Hyd. Flow GPM	GPM at 10 PSI	GPM at 20 PSI	GPM at 30 PSI	GPM at 40 PSI	GPM at 50 PSI	GPM at 60 PSI	GPM at 70 PSI	GPM at 80 PSI	GPM at 90 PSI	GPM at 100 PSI	GPM at 110 PSI
6	65	63	59	51	41	29	12				
7	72	72	71	67	60	51	42	31	17		
8	72	72	72	72	70	64	57	50	42	32	16

9302C-HM4C, 9302S-HM4C

METRIC UNITS

Hyd. Flow LPM	LPM at 0.7 BAR	LPM at 1.4 BAR	LPM at 2.1 BAR	LPM at 2.8 BAR	LPM at 3.4 BAR	LPM at 4.1 BAR	LPM at 4.8 BAR	LPM at 5.5 BAR	LPM at 6.2 BAR	LPM at 6.9 BAR	LPM at 7.6 BAR
22.7	246	238	223	193	155	110	45				
26.5	273	273	269	254	227	193	159	117	64		
30.3	273	273	273	273	265	242	216	189	159	121	61

9303C and 9303S Series

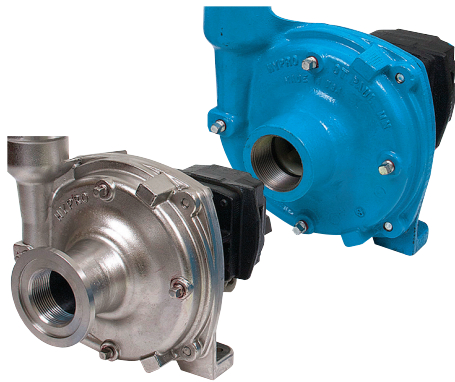

UPGRADE OPTIONS

- ◆ Increase dry-run and abrasive resistance with Life Guard Seals
 - Life Guard seals are the OEM standard
- ◆ Extend pump life with Stainless Steel
 - Chemical corrosion, pump cavitation, and abrasive wear are key factors in pump life
 - 316 Stainless Steel pumps provide superior chemical corrosion resistance, while maintaining material strength to prolong the life against abrasive wear
 - 316 Stainless Steel resists cavitation pitting of pumps, extending the wear life
 - Drop in replacements for cast iron pumps

FEATURES

- ◆ Hydraulic motor drive (for open center, closed center and load-sensing systems)
- ◆ Port sizes: 1-1/2" NPT inlet, 1-1/4" NPT outlet
- ◆ 220 x 200 universal flange available (U)
- ◆ Max. fluid temperature: 140°F/60°C
- ◆ Impeller: Cast Iron models - Nylon; (GTX available) Stainless Steel models - Polypropylene
- ◆ Motor: internal gear gerotor
- ◆ Hydraulic ports: 1/2" NPT inlet, 3/4" NPT outlet

- ◆ Pump seals: Cast Iron models - Viton®/ceramic standard; Life Guard silicon carbide (B) available; Stainless Steel models - Life Guard silicon carbide standard
- ◆ Life Guard seals are the industry standard on OEM equipment
- ◆ Hydraulic motor seal: double-lip Teflon®
- ◆ Max. motor psi: 3000 (bar: 207)
- ◆ Weight: 26 lbs./11.8 kg
- ◆ Flanged connections need universal flange gasket and universal flange clamp

ORDERING INFORMATION

Model Number	Max GPM	Max LPM	Max PSI	Max BAR	Max Hyd. GPM	Max Hyd. LPM	Hydraulic Selection System
9303C-HM1C	114	432	130	9.0	13	49.2	Open/Closed
9303C-HM2C	97	367	95	6.5	6	22.7	Open/Closed
9303C-HM3C	125	473	98	6.8	24	90.8	Open/Closed
9303C-HM4C	115	435	93	6.4	7	26.5	Open/Closed
9303C-HM5C	147	556	145	10.0	16	60.6	Open/Closed
9303S-HM1C	114	432	130	9.0	13	49.2	Open/Closed
9303S-HM2C	97	367	95	6.5	6	22.7	Open/Closed
9303S-HM3C	125	473	98	6.8	24	90.8	Open/Closed
9303S-HM4C	115	435	93	6.4	7	26.5	Open/Closed
9303S-HM5C	147	556	145	10.0	16	60.6	Open/Closed
3430-0332							Seal and o-ring repair kit
3430-0589							Life Guard silicon carbide seal kit

Universal Flange (220 x 200) - Add suffix "U" (i.e.: 9303C-HM3C-U)
 Life Guard silicon carbide seal - Add suffix "B" (i.e.: 9303C-HM1C-B)

9303C-HM1C, 9303S-HM1C

U.S. UNITS

Hyd. Flow GPM	GPM at 20 PSI	GPM at 30 PSI	GPM at 40 PSI	GPM at 50 PSI	GPM at 60 PSI	GPM at 70 PSI	GPM at 80 PSI	GPM at 90 PSI	GPM at 100 PSI	GPM at 110 PSI	GPM at 120 PSI
11	104	101	96	90	82	71	60	47	31		
12	110	109	107	105	101	92	81	67	53	36	9
13	112	111	109	107	104	102	96	85	76	63	33

9303C-HM1C, 9303S-HM1C

METRIC UNITS

Hyd. Flow LPM	LPM at 1.4 BAR	LPM at 2.1 BAR	LPM at 2.8 BAR	LPM at 3.4 BAR	LPM at 4.1 BAR	LPM at 4.8 BAR	LPM at 5.5 BAR	LPM at 6.2 BAR	LPM at 6.9 BAR	LPM at 7.6 BAR	LPM at 8.3 BAR
41.6	394	382	363	341	310	269	227	178	117		
45.4	416	413	405	397	382	348	307	254	201	136	34
49.2	424	420	413	405	394	386	363	322	288	238	125

9303C and 9303S Series

9303C-HM2C, 9303S-HM2C

U.S. UNITS

Hyd. Flow GPM	GPM at 10 PSI	GPM at 20 PSI	GPM at 30 PSI	GPM at 40 PSI	GPM at 50 PSI	GPM at 60 PSI	GPM at 70 PSI	GPM at 80 PSI	GPM at 90 PSI
4	70	60	45	25					
5	83	74	65	50	37	22	4		
6	94	86	80	72	62	50	37	22	7

9303C-HM2C, 9303S-HM2C

METRIC UNITS

Hyd. Flow LPM	LPM at 0.7 BAR	LPM at 1.4 BAR	LPM at 2.1 BAR	LPM at 2.8 BAR	LPM at 3.4 BAR	LPM at 4.1 BAR	LPM at 4.8 BAR	LPM at 5.5 BAR	LPM at 6.2 BAR
15.1	265	227	170	95					
18.9	314	280	246	189	140	83	15		
22.7	356	326	303	273	235	189	140	83	26

9303C-HM3C, 9303S-HM3C

U.S. UNITS

Hyd. Flow GPM	GPM at 10 PSI	GPM at 20 PSI	GPM at 30 PSI	GPM at 40 PSI	GPM at 50 PSI	GPM at 60 PSI	GPM at 70 PSI	GPM at 80 PSI	GPM at 90 PSI
15	100	92	83	69	47				
18	116	114	108	100	90	76	55	33	
20	125	123	120	114	107	96	85	71	50

9303C-HM3C, 9303S-HM3C

METRIC UNITS

Hyd. Flow LPM	LPM at 0.7 BAR	LPM at 1.4 BAR	LPM at 2.1 BAR	LPM at 2.8 BAR	LPM at 3.4 BAR	LPM at 4.1 BAR	LPM at 4.8 BAR	LPM at 5.5 BAR	LPM at 6.2 BAR
56.8	379	348	314	261	178				
68.1	439	432	409	379	341	288	208	125	
75.7	473	466	454	432	405	363	322	269	189

9303C-HM4C, 9303S-HM4C

U.S. UNITS

Hyd. Flow GPM	GPM at 10 PSI	GPM at 20 PSI	GPM at 30 PSI	GPM at 40 PSI	GPM at 50 PSI	GPM at 60 PSI	GPM at 70 PSI	GPM at 80 PSI	GPM at 90 PSI
5	84	76	66	52	34				
6	97	92	86	78	67	50	25		
7	110	104	98	91	82	69	55	38	14

9303C-HM4C, 9303S-HM4C

METRIC UNITS

Hyd. Flow LPM	LPM at 0.7 BAR	LPM at 1.4 BAR	LPM at 2.1 BAR	LPM at 2.8 BAR	LPM at 3.4 BAR	LPM at 4.1 BAR	LPM at 4.8 BAR	LPM at 5.5 BAR	LPM at 6.2 BAR
18.9	318	288	250	197	129				
22.7	367	348	326	295	254	189	95		
26.5	416	394	371	344	310	261	208	144	53

9303C-HM5C, 9303S-HM5C

U.S. UNITS

Hyd. Flow GPM	GPM at 30 PSI	GPM at 40 PSI	GPM at 50 PSI	GPM at 60 PSI	GPM at 70 PSI	GPM at 80 PSI	GPM at 90 PSI	GPM at 100 PSI	GPM at 110 PSI	GPM at 120 PSI	GPM at 130 PSI
13	113	105	97	86	73	59	44				
14	128	123	116	108	98	88	74	61	44		
15	135	132	126	119	110	100	89	77	66	50	20
16	145	142	137	132	126	117	107	95	83	70	55

9303C-HM5C, 9303S-HM5C

METRIC UNITS

Hyd. Flow LPM	LPM at 2.1 BAR	LPM at 2.8 BAR	LPM at 3.4 BAR	LPM at 4.1 BAR	LPM at 4.8 BAR	LPM at 5.5 BAR	LPM at 6.2 BAR	LPM at 6.9 BAR	LPM at 7.6 BAR	LPM at 8.3 BAR	LPM at 9.0 BAR
49.2	428	397	367	326	276	223	167				
53.0	485	466	439	409	371	333	280	231	167		
56.8	511	500	477	450	416	379	337	291	250	189	76
60.6	549	538	519	500	477	443	405	360	314	265	208

9313 Series



UPGRADE OPTIONS

- ◆ Extend pump life with Stainless Steel
 - Chemical corrosion, pump cavitation, and abrasive wear are key factors in pump life
 - 316 Stainless Steel pumps provide superior chemical corrosion resistance, while maintaining material strength to prolong life against abrasive wear
 - 316 Stainless Steel resists cavitation pitting of pumps, extending wear life
- ◆ Hydraulic motor with case drain for maximum motor life

FEATURES

- ◆ ForceField Technology is a superior wet seal technology that provides the ultimate protection for the mechanical seal and avoids costly downtime
- ◆ Protects the mechanical seal against common failures related to dry run and chemical bonding by using a barrier fluid to keep it cool and lubricated
- ◆ Actively maintains a pressure differential between the barrier fluid and the pumping solution, which results in longer life and worry free operation.
- ◆ Capable of flows up to 197 GPM (746 LPM) and can produce up to 150 PSI (10.3 bar)
- ◆ Designed to be a drop-in replacement for standard Hypro hydraulically driven centrifugal pumps
- ◆ One year warranty covering pump, motor and seals
- ◆ Flanged connections need universal flange gasket and universal flange clamp

ORDERING INFORMATION

Part Number	Current Product Equivalent	Inlet/Outlet	Max GPM	Max LPM	Max PSI	Max Bar	Max Hyd. GPM	Max Hyd. LPM
9313C-M04	9303C-HM2C	1-1/2" NPT x 1-1/4" NPT	140	530	90	6.2	7	26.5
9313CU-M04	9303C-HM2C-U	220 x 200 Universal Flange	140	530	90	6.2	7	26.5
9313C-M05	9303C-HM4C	1-1/2" NPT x 1-1/4" NPT	155	587	100	6.9	8	30.3
9313CU-M05	9303C-HM4C-U	220 x 200 Universal Flange	155	587	100	6.9	8	30.3
9313C-M08	9303C-HM1C	1-1/2" NPT x 1-1/4" NPT	188	712	137	9.4	13	49.2
9313CU-M08	9303C-HM1C-U	220 x 200 Universal Flange	188	712	137	9.4	13	49.2
9313C-M10	9303C-HM5C	1-1/2" NPT x 1-1/4" NPT	197	746	150	10.3	16	60.6
9313CU-M10	9303C-HM5C-U	220 x 200 Universal Flange	197	746	150	10.3	16	60.6
9313C-M16	9303C-HM3C	1-1/2" NPT x 1-1/4" NPT	194	734	103	7.1	20	75.7
9313CU-M16	9303C-HM3C-U	220 x 200 Universal Flange	194	734	103	7.1	20	75.7
9313S-M04	9303S-HM2C	1-1/2" NPT x 1-1/4" NPT	140	530	90	6.2	7	26.5
9313SU-M04	9303S-HM2C-U	220 x 200 Universal Flange	140	530	90	6.2	7	26.5
9313S-M05	9303S-HM4C	1-1/2" NPT x 1-1/4" NPT	155	587	100	6.9	8	30.3
9313SU-M05	9303S-HM4C-U	220 x 200 Universal Flange	155	587	100	6.9	8	30.3
9313S-M08	9303S-HM1C	1-1/2" NPT x 1-1/4" NPT	188	712	137	9.4	13	49.2
9313SU-M08	9303S-HM1C-U	220 x 200 Universal Flange	188	712	137	9.4	13	49.2
9313S-M10	9303S-HM5C	1-1/2" NPT x 1-1/4" NPT	197	746	150	10.3	16	60.6
9313SU-M10	9303S-HM5C-U	220 x 200 Universal Flange	197	746	150	10.3	16	60.6
9313S-M16	9303S-HM3C	1-1/2" NPT x 1-1/4" NPT	194	734	103	7.1	20	75.7
9313SU-M16	9303S-HM3C-U	220 x 200 Universal Flange	194	734	103	7.1	20	75.7

Case Drain motor available - Add suffix "Y" (i.e. 9313CU-M08Y)

9313C-M04, 9313CU-M04, 9313S-M04, 9313SU-M04

U.S. UNITS

Hyd. Flow GPM	GPM at 10 PSI	GPM at 20 PSI	GPM at 30 PSI	GPM at 40 PSI	GPM at 50 PSI	GPM at 60 PSI	GPM at 70 PSI	GPM at 80 PSI
5	128	111	85	60	36	15		
6	134*	120	97	74	55	36	18	
7	140*	127	104	83	64	45	29	14

9313C-M04, 9313CU-M04, 9313S-M04, 9313SU-M04

METRIC UNITS

Hyd. Flow LPM	LPM at 0.7 BAR	LPM at 1.4 BAR	LPM at 2.1 BAR	LPM at 2.8 BAR	LPM at 3.4 BAR	LPM at 4.1 BAR	LPM at 4.8 BAR	LPM at 5.5 BAR
18.9	485	420	322	227	136	57		
22.7	507*	454	367	280	208	136	68	
26.5	530*	481	394	314	242	170	110	53

9313 Series

9313C-M05, 9313CU-M05, 9313S-M05, 9313SU-M05

U.S. UNITS

Hyd. Flow GPM	GPM at 10 PSI	GPM at 20 PSI	GPM at 30 PSI	GPM at 40 PSI	GPM at 50 PSI	GPM at 60 PSI	GPM at 70 PSI	GPM at 80 PSI	GPM at 90 PSI
6	144*	130	106	82	58	30			
7	150*	138	119	96	75	55	34	14	
8	155*	145*	130	108	88	70	52	35	17

9313C-M05, 9313CU-M05, 9313S-M05, 9313SU-M05

METRIC UNITS

Hyd. Flow LPM	LPM at 0.7 BAR	LPM at 1.4 BAR	LPM at 2.1 BAR	LPM at 2.8 BAR	LPM at 3.4 BAR	LPM at 4.1 BAR	LPM at 4.8 BAR	LPM at 5.5 BAR	LPM at 6.2 BAR
22.7	545*	492	401	310	220	114			
26.5	568*	522*	450	363	284	208	129	53	
30.3	587*	549*	492	409	333	265	197	132	64

9313C-M08, 9313CU-M08, 9313S-M08, 9313SU-M08

U.S. UNITS

Hyd. Flow GPM	GPM at 20 PSI	GPM at 30 PSI	GPM at 40 PSI	GPM at 50 PSI	GPM at 60 PSI	GPM at 70 PSI	GPM at 80 PSI	GPM at 90 PSI	GPM at 100 PSI	GPM at 110 PSI	GPM at 120 PSI
11	178*	169*	157*	138	117	97	72	48	22		
12	183*	176*	165*	149*	131	111	93	74	52	29	
13	188*	182*	173*	159*	141	124	106	89	71	53	33

9313C-M08, 9313CU-M08, 9313S-M08, 9313SU-M08

METRIC UNITS

Hyd. Flow LPM	LPM at 1.4 BAR	LPM at 2.1 BAR	LPM at 2.8 BAR	LPM at 3.4 BAR	LPM at 4.1 BAR	LPM at 4.8 BAR	LPM at 5.5 BAR	LPM at 6.2 BAR	LPM at 6.9 BAR	LPM at 7.6 BAR	LPM at 8.3 BAR
41.6	674*	640*	594*	522	443	367	273	182	83		
45.4	693*	666*	625*	564*	496	420	352	280	197	110	
49.2	712*	689*	655*	602*	534	469	401	337	269	201	125

9313C-M10, 9313CU-M10, 9313S-M10, 9313SU-M10

U.S. UNITS

Hyd. Flow GPM	GPM at 30 PSI	GPM at 40 PSI	GPM at 50 PSI	GPM at 60 PSI	GPM at 70 PSI	GPM at 80 PSI	GPM at 90 PSI	GPM at 100 PSI	GPM at 110 PSI	GPM at 120 PSI	GPM at 130 PSI
13	185*	176*	162*	143	122	99	68	24			
14	190*	183*	172*	155*	137	117	96	70	35		
15	193*	187*	179*	168*	154*	135	113	91	66	41	16
16	197*	192*	186*	178*	166*	150	132	114	96	76	55

9313C-M10, 9313CU-M10, 9313S-M10, 9313SU-M10

METRIC UNITS

Hyd. Flow LPM	LPM at 2.1 BAR	LPM at 2.8 BAR	LPM at 3.4 BAR	LPM at 4.1 BAR	LPM at 4.8 BAR	LPM at 5.5 BAR	LPM at 6.2 BAR	LPM at 6.9 BAR	LPM at 7.6 BAR	LPM at 8.3 BAR	LPM at 9.0 BAR
49.2	700*	666*	613*	541	462	375	257	91			
53.0	719*	693*	651*	587*	519	443	363	265	132		
56.8	731*	708*	678*	636*	583*	511	428	344	250	155	61
60.6	746*	727*	704*	674*	628*	568	500	432	363	288	208

9313C-M16, 9313CU-M16, 9313S-M16, 9313SU-M16

U.S. UNITS

Hyd. Flow GPM	GPM at 20 PSI	GPM at 30 PSI	GPM at 40 PSI	GPM at 50 PSI	GPM at 60 PSI	GPM at 70 PSI	GPM at 80 PSI	GPM at 90 PSI	GPM at 100 PSI
16	168*	154*	134	105	66				
18	185*	177*	165*	145*	119	85	41		
20	194*	190*	184*	175*	160*	139	115	78	20

9313C-M16, 9313CU-M16, 9313S-M16, 9313SU-M16

METRIC UNITS

Hyd. Flow LPM	LPM at 1.4 BAR	LPM at 2.1 BAR	LPM at 2.8 BAR	LPM at 3.4 BAR	LPM at 4.1 BAR	LPM at 4.8 BAR	LPM at 5.5 BAR	LPM at 6.2 BAR	LPM at 6.9 BAR
60.6	636*	583*	507*	397	250				
68.1	700*	670*	625*	549*	450	322	155		
75.7	734*	719*	697*	662*	606*	526	435	295	76

*Flow rates can only be achieved with sufficient NPSHA (Net Positive Suction Head Available), refer to OIPM for details.

HYDRAULICALLY-DRIVEN, CAST IRON & STAINLESS STEEL, SELF-PRIMING CENTRIGUAL PUMPS

9303C-SP and 9303S-SP Series



UPGRADE OPTIONS

- ◆ Increase dry-run and abrasive resistance with Life Guard Seals
 - Life Guard seals are the OEM standard
- ◆ Extend pump life with Stainless Steel
 - Chemical corrosion, pump cavitation, and abrasive wear are key factors in pump life
 - 316 Stainless Steel pumps provide superior chemical corrosion resistance, while maintaining material strength to prolong the life against abrasive wear
 - 316 Stainless Steel resists cavitation pitting of pumps, extending the wear life
 - Drop in replacements for cast iron pumps

FEATURES

- ◆ Available in cast iron and 316 stainless steel for extended pump life
- ◆ Hydraulic motor drive (for open center, closed center and load-sensing systems)
- ◆ Port sizes: 1-1/2" NPT inlet, 1-1/4" NPT outlet
- ◆ Max. fluid temperature: 140°F/60°C
- ◆ Impeller: Cast Iron models - Nylon; (GTX available)
Stainless Steel models - Polypropylene
- ◆ Motor: internal gear gerotor
- ◆ Hydraulic ports: 1/2" NPT inlet, 3/4" NPT outlet
- ◆ Max. motor psi: 3000 (bar: 207)
- ◆ Pump seals: Cast Iron models - Viton®/ceramic standard; Life Guard silicon carbide (B) available; Stainless Steel models - Life Guard silicon carbide standard
- ◆ Life Guard seals are the industry standard on OEM equipment
- ◆ Hydraulic motor seal: double-lip Teflon®
- ◆ Weight: 38 lbs./17.3 kg

ORDERING INFORMATION

Model Number	Max GPM	Max LPM	Max PSI	Max BAR	Max Hyd. GPM	Max Hyd. LPM	Hydraulic Selection System
9303C-HM1C-SP	122	462	130	9.0	13	49.2	Open/Closed
9303C-HM2C-SP	104	398	80	5.5	6	22.7	Open/Closed
9303C-HM3C-SP	120	454	95	6.5	20	90.8	Open/Closed
9303C-HM4C-SP	99	375	97	6.7	7	26.5	Open/Closed
9303C-HM5C-SP	140	530	140	9.7	16	60.5	Open/Closed
9303S-HM1C-SP	114	432	130	9.0	13	49.2	Open/Closed
9303S-HM2C-SP	97	361	95	6.5	6	22.7	Open/Closed
9303S-HM3C-SP	125	473	98	6.8	20	75.7	Open/Closed
9303S-HM4C-SP	99	435	93	6.4	7	26.5	Open/Closed
9303S-HM5C-SP	147	556	145	9.9	16	60.5	Open/Closed
3430-0589	Life Guard silicon carbide seal kit						
3430-0480SP	Self priming chamber kit						

Life Guard silicon carbide seal - Add suffix "B" (i.e.: 9303C-HM1C-SP-B)

9303C-HM1C-SP, 9303S-HM1C-SP

U.S. UNITS

Hyd. Flow GPM	GPM at 10 PSI	GPM at 20 PSI	GPM at 30 PSI	GPM at 40 PSI	GPM at 50 PSI	GPM at 60 PSI	GPM at 70 PSI	GPM at 80 PSI	GPM at 90 PSI	GPM at 100 PSI	GPM at 110 PSI
11	119	111	102	89	75	58	42	25			
12	122	120	113	104	94	81	69	55	39	24	
13	122	121	119	111	102	90	78	65	52	39	26

HYDRAULICALLY-DRIVEN, CAST IRON & STAINLESS STEEL, SELF-PRIMING

9303C-SP and 9303S-SP Series

9303C-HM1C-SP, 9303S-HM1C-SP

METRIC UNITS

Hyd. Flow LPM	LPM at 0.7 BAR	LPM at 1.4 BAR	LPM at 2.1 BAR	LPM at 2.8 BAR	LPM at 3.4 BAR	LPM at 4.1 BAR	LPM at 4.8 BAR	LPM at 5.5 BAR	LPM at 6.2 BAR	LPM at 6.9 BAR	LPM at 7.6 BAR
41.6	450	420	386	337	284	220	159	95			
45.4	462	454	428	394	356	307	261	208	148	91	
49.2	462	458	450	420	386	341	295	246	197	148	98

9303C-HM2C-SP, 9303S-HM2C-SP

U.S. UNITS

Hyd. Flow GPM	GPM at 10 PSI	GPM at 20 PSI	GPM at 30 PSI	GPM at 40 PSI	GPM at 50 PSI	GPM at 60 PSI	GPM at 70 PSI
4	57	43	26				
5	80	67	53	39	23		
6	98	88	78	67	55	42	29

9303C-HM2C-SP, 9303S-HM2C-SP

METRIC UNITS

Hyd. Flow LPM	LPM at 0.7 BAR	LPM at 1.4 BAR	LPM at 2.1 BAR	LPM at 2.8 BAR	LPM at 3.4 BAR	LPM at 4.1 BAR	LPM at 4.8 BAR
15.1	216	163	98				
18.9	303	254	201	148	87		
22.7	371	333	295	254	208	159	110

9303C-HM3C-SP, 9303S-HM3C-SP

U.S. UNITS

Hyd. Flow GPM	GPM at 10 PSI	GPM at 20 PSI	GPM at 30 PSI	GPM at 40 PSI	GPM at 50 PSI	GPM at 60 PSI	GPM at 70 PSI	GPM at 80 PSI
15	104	90	74	55	23			
18	119	113	102	87	69	46		
20	120	119	114	106	91	74	55	33

9303C-HM3C-SP, 9303S-HM3C-SP

METRIC UNITS

Hyd. Flow LPM	LPM at 0.7 BAR	LPM at 1.4 BAR	LPM at 2.1 BAR	LPM at 2.8 BAR	LPM at 3.4 BAR	LPM at 4.1 BAR	LPM at 4.8 BAR	LPM at 5.5 BAR
56.8	394	341	280	208	87			
68.1	450	428	386	329	261	174		
75.7	454	450	432	401	344	280	208	125

9303C-HM4C-SP, 9303S-HM4C-SP

U.S. UNITS

Hyd. Flow GPM	GPM at 10 PSI	GPM at 20 PSI	GPM at 30 PSI	GPM at 40 PSI	GPM at 50 PSI	GPM at 60 PSI	GPM at 70 PSI	GPM at 80 PSI
5	72	60	46	30	15			
6	87	79	66	52	38	27	13	
7	95	91	84	71	58	42	30	16

9303C-HM4C-SP, 9303S-HM4C-SP

METRIC UNITS

Hyd. Flow LPM	LPM at 0.7 BAR	LPM at 1.4 BAR	LPM at 2.1 BAR	LPM at 2.8 BAR	LPM at 3.4 BAR	LPM at 4.1 BAR	LPM at 4.8 BAR	LPM at 5.5 BAR
18.9	273	227	174	114	57			
22.7	329	299	250	197	144	102	49	
26.5	360	344	318	269	220	159	114	61

9303C-HM5C-SP, 9303S-HM5C-SP

U.S. UNITS

Hyd. Flow GPM	GPM at 10 PSI	GPM at 20 PSI	GPM at 30 PSI	GPM at 40 PSI	GPM at 50 PSI	GPM at 60 PSI	GPM at 70 PSI	GPM at 80 PSI	GPM at 90 PSI	GPM at 100 PSI	GPM at 110 PSI
41.6	450	420	386	337	284	220	159	95			
45.4	462	454	428	394	356	307	261	208	148	91	
49.2	462	458	450	420	386	341	295	246	197	148	98

9303C-HM5C-SP, 9303S-HM5C-SP

METRIC UNITS

Hyd. Flow LPM	LPM at 0.7 BAR	LPM at 1.4 BAR	LPM at 2.1 BAR	LPM at 2.8 BAR	LPM at 3.4 BAR	LPM at 4.1 BAR	LPM at 4.8 BAR	LPM at 5.5 BAR	LPM at 6.2 BAR	LPM at 6.9 BAR	LPM at 7.6 BAR
49.2	432	420	386	337	284	220	159	95			
53.0	447	443	428	394	356	307	261	208	148	91	
56.8	462	458	450	420	386	341	295	246	197	148	98

9303P Series



FEATURES

- ◆ Hydraulic motor drive (for open center, closed center and load-sensing systems)
- ◆ Port sizes: 1-1/2" NPT inlet, 1-1/4" NPT outlet
- ◆ Max. fluid temperature: 140°F/60°C
- ◆ Housing: Polypropylene
- ◆ Impeller: Polypropylene
- ◆ Motor: internal gear gerotor
- ◆ Hydraulic ports: 1/2" NPT inlet, 3/4" NPT outlet
- ◆ Pump seals: Viton®/ceramic standard; Life Guard silicon carbide (B) available
- ◆ Life Guard seals are the industry standard on OEM equipment
- ◆ Hydraulic motor seal: double-lip Teflon®
- ◆ Max. motor psi: 3000 (bar: 207)
- ◆ Weight: 21 lbs./9.5 kg

ORDERING INFORMATION

Model Number	Max GPM	Max LPM	Max PSI	Max BAR	Max Hyd. GPM	Max Hyd. LPM	Hydraulic Selection System
9303P-HM1C	110	416	130	9.0	13	49.2	Open/Closed
9303P-HM2C	82	310	95	6.5	6	22.7	Open/Closed
9303P-HM4C	82	310	84	5.3	7	26.5	Open/Closed
9303P-HM5C	113	427	120	8.3	16	60.5	Open/Closed
3430-0445	Seal and o-ring repair kit						
3430-0593	Life Guard silicon carbide seal kit						

Life Guard silicon carbide seal - Add suffix "B" (i.e.: 9303P-HM1C-B)

9303P-HM1C

U.S. UNITS

Hyd. Flow GPM	GPM at 10 PSI	GPM at 20 PSI	GPM at 30 PSI	GPM at 40 PSI	GPM at 50 PSI	GPM at 60 PSI	GPM at 70 PSI	GPM at 80 PSI	GPM at 90 PSI	GPM at 100 PSI	GPM at 110 PSI	GPM at 120 PSI
11	93	90	86	80	74	67	59	49	36	18		
12	102	99	95	91	87	81	74	66	55	39	19	
13	109	106	103	99	94	88	82	74	65	54	42	28

9303P Series

9303P-HM1C

METRIC UNITS

Hyd. Flow LPM	LPM at 0.7 BAR	LPM at 1.4 BAR	LPM at 2.1 BAR	LPM at 2.8 BAR	LPM at 3.4 BAR	LPM at 4.1 BAR	LPM at 4.8 BAR	LPM at 5.5 BAR	LPM at 6.2 BAR	LPM at 6.9 BAR	LPM at 7.6 BAR	LPM at 8.3 BAR
41.6	352	341	326	303	280	254	223	185	136	68		
45.4	386	375	360	344	329	307	280	250	208	148	72	
49.2	413	401	390	375	356	333	310	280	246	204	159	106

UPGRADE OPTIONS

◆ Increase abrasive resistance with Life Guard Seals

U.S. UNITS

Hyd. Flow GPM	GPM at 10 PSI	GPM at 20 PSI	GPM at 30 PSI	GPM at 40 PSI	GPM at 50 PSI	GPM at 60 PSI	GPM at 70 PSI	GPM at 80 PSI	GPM at 90 PSI
5	65	56	46	38	20				
6	74	72	64	56	48	38	21		
7	80	75	70	62	57	48	40	28	9

9303P-HM2C

METRIC UNITS

Hyd. Flow LPM	LPM at 0.7 BAR	LPM at 1.4 BAR	LPM at 2.1 BAR	LPM at 2.8 BAR	LPM at 3.4 BAR	LPM at 4.1 BAR	LPM at 4.8 BAR	LPM at 5.5 BAR	LPM at 6.2 BAR
18.9	246	212	174	144	76				
22.7	280	273	242	212	182	144	79		
26.5	303	284	265	235	216	182	151	106	34

9303P-HM4C

U.S. UNITS

Hyd. Flow GPM	GPM at 10 PSI	GPM at 20 PSI	GPM at 30 PSI	GPM at 40 PSI	GPM at 50 PSI	GPM at 60 PSI	GPM at 70 PSI	GPM at 80 PSI
5	60	52	41	26				
6	70	66	58	48	37	21		
7	80	76	70	63	55	45	32	15

9303P-HM4C

METRIC UNITS

Hyd. Flow LPM	LPM at 0.7 BAR	LPM at 1.4 BAR	LPM at 2.1 BAR	LPM at 2.8 BAR	LPM at 3.4 BAR	LPM at 4.1 BAR	LPM at 4.8 BAR	LPM at 5.5 BAR
18.9	227	197	155	98				
22.7	265	250	220	182	140	79		
26.5	303	288	265	238	208	170	121	57

9303P-HM5C

U.S. UNITS

Hyd. Flow GPM	GPM at 10 PSI	GPM at 20 PSI	GPM at 30 PSI	GPM at 40 PSI	GPM at 50 PSI	GPM at 60 PSI	GPM at 70 PSI	GPM at 80 PSI	GPM at 90 PSI	GPM at 100 PSI	GPM at 110 PSI
12	94	92	86	78	68	58	44	15			
13	100	98	94	88	79	70	60	48	25		
14	108	107	104	100	94	86	77	68	57	42	
15	113	112	110	106	100	93	86	78	68	56	40

9303P-HM1C 110 416 130 9.0 13 49.2 Open/Closed

9303P-HM5C

9303P-HM2C 82 310 95 6.5 6 22.7 Open/Closed

METRIC UNITS

Hyd. Flow LPM	LPM at 0.7 BAR	LPM at 1.4 BAR	LPM at 2.1 BAR	LPM at 2.8 BAR	LPM at 3.4 BAR	LPM at 4.1 BAR	LPM at 4.8 BAR	LPM at 5.5 BAR	LPM at 6.2 BAR	LPM at 6.9 BAR	LPM at 7.6 BAR
45.4	356	348	326	295	257	220	167	57			
49.2	379	371	356	333	299	265	227	182	95		
53.0	409	405	394	379	356	326	291	257	216	159	
56.8	428	424	416	401	379	352	326	295	257	212	151

9305C Series



UPGRADE OPTIONS

- ◆ Increase dry-run and abrasive resistance with Life Guard Seals
 - Life Guard seals are the OEM standard

FEATURES

- ◆ Available in cast iron
- ◆ Hydraulic motor drive (for open center, closed center and load-sensing systems)
- ◆ Port sizes: 2" NPT inlet, 1-1/2" NPT outlet
- ◆ Max. fluid temperature: 140°F/60°C
- ◆ Impeller: Nylon
- ◆ Motor: internal gear gerotor
- ◆ Hydraulic ports: 1/2" NPT inlet, 3/4" NPT outlet
- ◆ Max. motor psi: 3000 (bar: 207)
- ◆ Pump seals: Viton®/ceramic standard; Life Guard silicon carbide (B) available
- ◆ Life Guard seals are the industry standard on OEM equipment
- ◆ Hydraulic motor seal: double-lip Teflon®
- ◆ Weight: 48 lbs./21.8 kg

ORDERING INFORMATION

Model Number	Max GPM	Max LPM	Max PSI	Max BAR	Max Hyd. GPM	Max Hyd. LPM	Hydraulic Selection System
9305C-HM3C	182	689	156	10.8	19	72	Open/Closed
3430-0500	Seal and o-ring repair kit						
3430-0601	Life Guard silicon carbide seal kit						

Life Guard silicon carbide seal - Add suffix "B" (i.e.: 9305C-HM3C-B)

9305C-HM3C

U.S. UNITS

Hyd. Flow GPM	GPM at 50 PSI	GPM at 60 PSI	GPM at 70 PSI	GPM at 80 PSI	GPM at 90 PSI	GPM at 100 PSI	GPM at 110 PSI	GPM at 120 PSI	GPM at 130 PSI	GPM at 140 PSI
17	173	164	148	127	97	70	44	14		
18	177	175	168	154	135	109	87	62	34	
19	180	179	177	167	151	134	115	95	72	44

9305C-HM3C

METRIC UNITS

Hyd. Flow LPM	LPM at 3.4 BAR	LPM at 4.1 BAR	LPM at 4.8 BAR	LPM at 5.5 BAR	LPM at 6.2 BAR	LPM at 6.9 BAR	LPM at 7.6 BAR	LPM at 8.3 BAR	LPM at 9.0 BAR	LPM at 9.7 BAR
64.4	655	621	560	481	367	265	167	53		
68.1	670	662	636	583	511	413	329	235	129	
71.9	685	678	670	632	572	507	435	360	273	167

9305C-SP and 9305C-BSP Series



UPGRADE OPTIONS

- ◆ Increase dry-run and abrasive resistance with Life Guard Seals
 - Life Guard seals are the OEM standard

FEATURES

- ◆ Available in cast iron
- ◆ Hydraulic motor drive (for open center, closed center and load-sensing systems)
- ◆ Port sizes: 2" NPT inlet, 2" NPT outlet (Model 9305C-HM3C-SP), 2" BSP inlet, 2" BSP outlet (Model 9305C-HM3C-BSP)
- ◆ Max. fluid temperature: 140°F/60°C
- ◆ Impeller: Nylon
- ◆ Motor: internal gear gerotor
- ◆ Hydraulic ports: 1/2" NPT inlet, 3/4" NPT outlet
- ◆ Max. motor psi: 3000 (bar: 207)
- ◆ Pump seals: Viton®/ceramic standard; Life Guard silicon carbide (B) available
- ◆ Life Guard seals are the industry standard on OEM equipment
- ◆ Hydraulic motor seal: double-lip Teflon®
- ◆ Weight: 59 lbs./26.8 kg

ORDERING INFORMATION

Model Number	Max GPM	Max LPM	Max PSI	Max BAR	Max Hyd. GPM	Max Hyd LPM	Hydraulic Selection System
9305C-HM3C-SP	155	587	143	9.9	19	72	Open/Closed
9305C-HM3C-BSP	155	587	143	9.9	19	72	Open/Closed
3430-0601	Life Guard silicon carbide seal kit						

Life Guard silicon carbide seal - Add suffix "B" (i.e.: 9305C-HM3C-B-SP)

9305C-HM3C-SP, 9305C-HM3C-BSP

U.S. UNITS

Hyd. Flow GPM	GPM at 30 PSI	GPM at 40 PSI	GPM at 50 PSI	GPM at 60 PSI	GPM at 70 PSI	GPM at 80 PSI	GPM at 90 PSI	GPM at 100 PSI	GPM at 110 PSI	GPM at 120 PSI	GPM at 130 PSI
17	148	145	135	118	100	81	60	37	17		
18	150	149	147	138	120	102	81	60	38	14	
19	153	152	150	147	140	120	104	85	66	45	28

9305C-HM3C-SP, 9305C-HM3C-BSP

METRIC UNITS

Hyd. Flow LPM	LPM at 2.1 BAR	LPM at 2.8 BAR	LPM at 3.4 BAR	LPM at 4.1 BAR	LPM at 4.8 BAR	LPM at 5.5 BAR	LPM at 6.2 BAR	LPM at 6.9 BAR	LPM at 7.6 BAR	LPM at 8.3 BAR	LPM at 9.0 BAR
64.4	560	549	511	447	379	307	227	140	64		
68.1	568	564	556	522	454	386	307	227	144	53	
71.9	579	575	568	556	553	454	394	322	250	170	106

9306C and 9306S Series

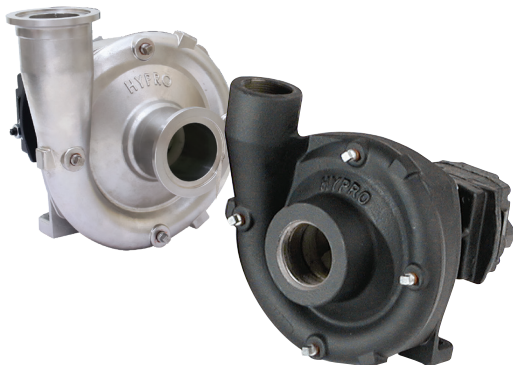

UPGRADE OPTIONS

- ◆ Increase dry-run and abrasive resistance with Life Guard Seals
 - Life Guard seals are the OEM standard
- ◆ Extend pump life with Stainless Steel
 - Chemical corrosion, pump cavitation, and abrasive wear are key factors in pump life
 - 316 Stainless Steel pumps provide superior chemical corrosion resistance, while maintaining material strength to prolong the life against abrasive wear
 - 316 Stainless Steel resists cavitation pitting of pumps, extending the wear life
 - Drop in replacements for cast iron pumps

FEATURES

- ◆ Hydraulic motor drive (for open center, closed center and load-sensing systems)
- ◆ Port sizes: 2" NPT inlet, 1-1/2" NPT outlet; 220 x 220 (U) Universal flange available
- ◆ Max. fluid temperature: 140°F/60°C
- ◆ Available in cast iron and 316 stainless steel for extended pump life
- ◆ Impeller: Nylon (cast iron models); polypropylene (stainless steel models); (GTX available)
- ◆ Motor: internal gear gerotor
- ◆ Hydraulic ports: 1/2" NPT inlet, 3/4" NPT outlet
- ◆ Max. motor psi: 3000 (bar: 207)
- ◆ Pump seals: Cast Iron models - Viton®/ceramic standard; Life Guard silicon carbide (B) available; Stainless Steel models - Life Guard silicon carbide standard
- ◆ Life Guard seals are the industry standard on OEM equipment
- ◆ Hydraulic motor seal: double-lip Teflon®
- ◆ Weight: 33 lbs./15 kg
- ◆ Flanged connections need universal flange gasket and universal flange clamp

ORDERING INFORMATION

Model Number	Max GPM	Max LPM	Max PSI	Max BAR	Max Hyd. GPM	Max Hyd. LPM	Hydraulic Selection System
9306C-HM1C*	207	784	127	8.8	13	49.2	Open/Closed
9306C-HM3C*	214	810	128	8.8	24	90.8	Open/Closed
9306C-HM5C*	212	803	140	9.6	17	64.4	Open/Closed
9306S-HM1C	207	784	127	8.8	13	49.2	Open/Closed
9306S-HM3C	214	810	128	8.8	24	90.8	Open/Closed
9306S-HM5C	212	803	140	9.6	17	64.4	Open/Closed
3430-0332	Seal and o-ring repair kit						
3430-0589	Life Guard silicon carbide seal kit						

*Universal Flange (220 x 220) - Add Suffix "U" (i.e.: 9306C-HM3C-U) - Life Guard silicon carbide seal - Add suffix "B" (i.e.: 9306C-HM3C-B)

9306C and 9306S Series

9306C-HM1C, 9306S-HM1C, 9306C-HM1C-U, 9306S-HM1C-U

U.S. UNITS

Hyd. Flow GPM	GPM at 30 PSI	GPM at 40 PSI	GPM at 50 PSI	GPM at 60 PSI	GPM at 70 PSI	GPM at 80 PSI	GPM at 90 PSI	GPM at 100 PSI	GPM at 110 PSI	GPM at 120 PSI
11	207	200	186	155	122	88	44			
12	207	207	196	179	149	119	88	53		
13	207	207	207	195	171	144	115	85	53	20

9306C-HM1C, 9306S-HM1C, 9306C-HM1C-U, 9306S-HM1C-U

METRIC UNITS

Hyd. Flow LPM	LPM at 2.1 BAR	LPM at 2.8 BAR	LPM at 3.4 BAR	LPM at 4.1 BAR	LPM at 4.8 BAR	LPM at 5.5 BAR	LPM at 6.2 BAR	LPM at 6.9 BAR	LPM at 7.6 BAR	LPM at 8.3 BAR
41.6	784	757	704	587	462	333	167			
45.4	784	784	742	678	564	450	333	201		
49.2	784	784	784	738	647	545	435	322	201	76

9306C-HM3C, 9306S-HM3C, 9306C-HM3C-U, 9306S-HM3C-U

U.S. UNITS

Hyd. Flow GPM	GPM at 40 PSI	GPM at 50 PSI	GPM at 60 PSI	GPM at 70 PSI	GPM at 80 PSI	GPM at 90 PSI	GPM at 100 PSI	GPM at 110 PSI	GPM at 120 PSI
18	190	179	159	90					
20	214	203	199	181	139	49			
22	214	214	214	210	198	176	127	16	
24	214	214	214	214	214	210	190	154	101

9306C-HM3C, 9306S-HM3C, 9306C-HM3C-U, 9306S-HM3C-U

METRIC UNITS

Hyd. Flow LPM	LPM at 2.8 BAR	LPM at 3.4 BAR	LPM at 4.1 BAR	LPM at 4.8 BAR	LPM at 5.5 BAR	LPM at 6.2 BAR	LPM at 6.9 BAR	LPM at 7.6 BAR	LPM at 8.3 BAR
68.1	719	678	602	341					
75.7	810	768	753	685	526	185			
83.3	810	810	810	795	750	666	481	61	
90.8	810	810	810	810	810	795	719	583	382

9306C-HM5C, 9306S-HM5C, 9306C-HM5C-U, 9306S-HM5C-U

U.S. UNITS

Hyd. Flow GPM	GPM at 40 PSI	GPM at 50 PSI	GPM at 60 PSI	GPM at 70 PSI	GPM at 80 PSI	GPM at 90 PSI	GPM at 100 PSI	GPM at 110 PSI	GPM at 120 PSI	GPM at 130 PSI
15	212	212	212	187	150	114	65	19		
16	212	212	212	212	189	158	125	87	42	
17	212	212	212	212	212	189	162	133	102	58

9306C-HM5C, 9306S-HM5C, 9306C-HM5C-U, 9306S-HM5C-U

METRIC UNITS

Hyd. Flow LPM	LPM at 2.8 BAR	LPM at 3.4 BAR	LPM at 4.1 BAR	LPM at 4.8 BAR	LPM at 5.5 BAR	LPM at 6.2 BAR	LPM at 6.9 BAR	LPM at 7.6 BAR	LPM at 8.3 BAR	LPM at 9.0 BAR
56.8	803	803	803	708	568	432	246	72		
60.6	803	803	803	803	715	598	473	329	159	
64.4	803	803	803	803	803	715	613	503	386	220

9306C-3U and 9306S-3U Series



UPGRADE OPTIONS

- ◆ Increase dry-run and abrasive resistance with Life Guard Seals
 - Life Guard seals are the OEM standard
- ◆ Extend pump life with Stainless Steel
 - Chemical corrosion, pump cavitation, and abrasive wear are key factors in pump life
 - 316 Stainless Steel pumps provide superior chemical corrosion resistance, while maintaining material strength to prolong the life against abrasive wear
 - 316 Stainless Steel resists cavitation pitting of pumps, extending the wear life
 - Drop in replacements for cast iron pumps

FEATURES

- ◆ Hydraulic motor drive (for open center, closed center and load-sensing systems)
- ◆ Port Sizes: 300 x 220 (3U) Universal flange
- ◆ Max. fluid temperature: 140°F/60°C
- ◆ Available in cast iron and 316 stainless steel for extended pump life
- ◆ Impeller: Nylon (cast iron models); polypropylene (stainless steel models); (GTX available)
- ◆ Motor: internal gear gerotor
- ◆ Hydraulic ports: 1/2" NPT inlet, 3/4" NPT outlet
- ◆ Max. motor psi: 3000 (bar: 207)
- ◆ Pump seals: Cast Iron models - Viton®/ceramic standard; Life Guard silicon carbide (B) available; Stainless Steel models - Life Guard silicon carbide
- ◆ Life Guard seals are the industry standard on OEM equipment
- ◆ Hydraulic motor seal: double-lip Teflon®
- ◆ Weight: 33 lbs./15 kg
- ◆ Flanged connections need universal flange gasket and universal flange clamp

ORDERING INFORMATION

Model Number	Max GPM	Max LPM	Max PSI	Max BAR	Max Hyd.GPM	Max Hyd. LPM	Hydraulic Selection System
9306C-HM1C-3U	283	1071	127	8.8	13	49.2	Open/Closed
9306C-HM3C-3U	322	1219	128	8.8	24	90.3	Open/Closed
9306C-HM5C-3U	312	1181	140	9.6	17	64.4	Open/Closed
9306S-HM1C-3U	283	1071	127	8.8	13	49.2	Open/Closed
9306S-HM3C-3U	322	1219	128	8.8	24	90.3	Open/Closed
9306S-HM5C-3U	312	1181	140	9.6	17	64.4	Open/Closed
3430-0332	Seal and o-ring repair kit						
3430-0589	Life Guard silicon carbide seal kit						

Life Guard silicon carbide seal - Add suffix "B" (i.e.: 9306C-HM1C-B3U)

9306C-3U and 9306S-3U Series

9306C-HM1C-3U, 9306S-HM1C-3U

U.S. UNITS

Hyd. Flow GPM	GPM at 30 PSI	GPM at 40 PSI	GPM at 50 PSI	GPM at 60 PSI	GPM at 70 PSI	GPM at 80 PSI	GPM at 90 PSI	GPM at 100 PSI	GPM at 110 PSI	GPM at 120 PSI
11	255	225	190	155	122	88	44	5		
12	271	242	211	179	149	119	88	53	19	
13	283	258	226	199	171	144	115	85	53	24

9306C-HM1C-3U, 9306S-HM1C-3U

METRIC UNITS

Hyd. Flow LPM	LPM at 2.1 BAR	LPM at 2.8 BAR	LPM at 3.4 BAR	LPM at 4.1 BAR	LPM at 4.8 BAR	LPM at 5.5 BAR	LPM at 6.2 BAR	LPM at 6.9 BAR	LPM at 7.6 BAR	LPM at 8.3 BAR
41.6	965	852	719	587	462	333	167	19		
45.4	1026	916	799	678	564	450	333	201	72	
49.2	1071	977	856	753	647	545	435	322	201	91

9306C-HM3C-3U, 9306S-HM3C-3U

U.S. UNITS

Hyd. Flow GPM	GPM at 30 PSI	GPM at 40 PSI	GPM at 50 PSI	GPM at 60 PSI	GPM at 70 PSI	GPM at 80 PSI	GPM at 90 PSI	GPM at 100 PSI	GPM at 110 PSI	GPM at 120 PSI
18	285	256	213	165	90					
20	308	297	268	233	192	139	49			
22	312	312	308	288	255	219	176	127	16	
24	322	322	320	316	298	265	231	196	154	101

9306C-HM3C-3U, 9306S-HM3C-3U

METRIC UNITS

Hyd. Flow LPM	LPM at 2.1 BAR	LPM at 2.8 BAR	LPM at 3.4 BAR	LPM at 4.1 BAR	LPM at 4.8 BAR	LPM at 5.5 BAR	LPM at 6.2 BAR	LPM at 6.9 BAR	LPM at 7.6 BAR	LPM at 8.3 BAR
68.1	1079	969	806	624	341					
75.7	1166	1124	1014	882	727	526	185			
83.3	1181	1181	1166	1090	965	829	666	481	61	
90.8	1219	1219	1211	1196	1128	1003	874	742	583	382

9306C-HM5C-3U, 9306S-HM5C-3U

U.S. UNITS

Hyd. Flow GPM	GPM at 30 PSI	GPM at 40 PSI	GPM at 50 PSI	GPM at 60 PSI	GPM at 70 PSI	GPM at 80 PSI	GPM at 90 PSI	GPM at 100 PSI	GPM at 110 PSI	GPM at 120 PSI	GPM at 130 PSI
15	285	269	242	212	182	149	112	68	19		
16	308	291	269	242	212	179	149	115	78	37	
17	312	312	297	270	242	214	187	154	122	82	44

9306C-HM5C-3U, 9306S-HM5C-3U

METRIC UNITS

Hyd. Flow LPM	LPM at 2.1 BAR	LPM at 2.8 BAR	LPM at 3.4 BAR	LPM at 4.1 BAR	LPM at 4.8 BAR	LPM at 5.5 BAR	LPM at 6.2 BAR	LPM at 6.9 BAR	LPM at 7.6 BAR	LPM at 8.3 BAR	LPM at 8.9 BAR
56.8	1079	1018	916	802	689	564	424	257	72		
60.6	1166	1101	1018	916	802	677	564	435	307	159	
64.4	1181	1181	1124	1022	916	810	708	583	462	310	167

9314 Series



UPGRADE OPTIONS

- ◆ Extend pump life with Stainless Steel
 - Chemical corrosion, pump cavitation, and abrasive wear are key factors in pump life
 - 316 Stainless Steel pumps provide superior chemical corrosion resistance, while maintaining material strength to prolong life against abrasive wear
 - 316 Stainless Steel resists cavitation pitting of pumps, extending wear life
- ◆ Hydraulic motor with case drain for maximum motor life

FEATURES

- ◆ ForceField Technology is a superior wet seal technology that provides the ultimate protection for the mechanical seal and avoids costly downtime
- ◆ Protects the mechanical seal against common failures related to dry run and chemical bonding by using a barrier fluid to keep it cool and lubricated
- ◆ Actively maintains a pressure differential between the barrier fluid and the pumping solution, which results in longer life and worry free operation.
- ◆ Capable of flows up to 233 GPM (882 LPM) and can produce up to 150 PSI (10.3 bar)
- ◆ Designed to be a drop-in replacement for standard Hypro hydraulically driven centrifugal pumps
- ◆ One year warranty covering pump, motor and seals
- ◆ Flanged connections need universal flange gasket and universal flange clamp

ORDERING INFORMATION

Model Number	Current Product Equivalent	Inlet/Outlet	Max GPM	Max LPM	Max PSI	Max Bar	Max Hyd. GPM	Max Hyd. LPM
9314C-M08	9306C-HM1C	2" NPT x 1-1/2" NPT	227	859	132	9.1	14	53
9314CU-M08	9306C-HM1C-U	220 x 220 Universal Flange	227	859	132	9.1	14	53
9314C-M10	9306C-HM5C	2" NPT x 1-1/2" NPT	233	882	150	10.3	17	64.4
9314CU-M10	9306C-HM5C-U	220 x 220 Universal Flange	233	882	150	10.3	17	64.4
9314C-M16	9306C-HM3C	2" NPT x 1-1/2" NPT	232	878	138	9.5	24	90.8
9314CU-M16	9306C-HM3C-U	220 x 220 Universal Flange	232	878	138	9.5	24	90.8
9314S-M08	9306S-HM1C	2" NPT x 1-1/2" NPT	227	859	132	9.1	14	53
9314SU-M08	9306S-HM1C-U	220 x 220 Universal Flange	227	859	132	9.1	14	53
9314S-M10	9306S-HM5C	2" NPT x 1-1/2" NPT	233	882	150	10.3	17	64.4
9314SU-M10	9306S-HM5C-U	220 x 220 Universal Flange	233	882	150	10.3	17	64.4
9314S-M16	9306S-HM3C	2" NPT x 1-1/2" NPT	232	878	138	9.5	24	90.8
9314SU-M16	9306S-HM3C-U	220 x 220 Universal Flange	232	878	138	9.5	24	90.8

Case Drain motor available - Add suffix "Y" (i.e. 9314CU-M08Y)

9314 Series

9314C-M08, 9314CU-M08, 9314S-M08, 9314SU-M08

U.S. UNITS

Hyd. Flow GPM	GPM at 30 PSI	GPM at 40 PSI	GPM at 50 PSI	GPM at 60 PSI	GPM at 70 PSI	GPM at 80 PSI	GPM at 90 PSI	GPM at 100 PSI	GPM at 110 PSI	GPM at 120 PSI
11	217	190	152	111	73	43	12			
12	224*	203	175	146	115	80	49	24		
13	226*	211*	186	160	131	106	81	56	29	
14	227*	216*	196	171	146	120	95	71	50	27

9314C-M08, 9314CU-M08, 9314S-M08, 9314SU-M08

METRIC UNITS

Hyd. Flow LPM	LPM at 2.1 BAR	LPM at 2.8 BAR	LPM at 3.4 BAR	LPM at 4.1 BAR	LPM at 4.8 BAR	LPM at 5.5 BAR	LPM at 6.2 BAR	LPM at 6.9 BAR	LPM at 7.6 BAR	LPM at 8.3 BAR
41.6	821	719	575	420	276	163	45			
45.4	848*	768	662	553	435	303	185	91		
49.2	856*	799*	704	606	496	401	307	212		
53.0	859*	818*	742	647	553	454	360	269	189	102

9314C-M10, 9314CU-M10, 9314S-M10, 9314SU-M10

U.S. UNITS

Hyd. Flow GPM	GPM at 40 PSI	GPM at 50 PSI	GPM at 60 PSI	GPM at 70 PSI	GPM at 80 PSI	GPM at 90 PSI	GPM at 100 PSI	GPM at 110 PSI	GPM at 120 PSI	GPM at 130 PSI
15	227*	217*	200	175	147	120	87	57	22	
16	231*	224*	212	190	163	136	111	83	53	17
17	233*	228*	220*	205	179	151	125	100	74	49

9314C-M10, 9314CU-M10, 9314S-M10, 9314SU-M10

METRIC UNITS

Hyd. Flow LPM	LPM at 2.8 BAR	LPM at 3.4 BAR	LPM at 4.1 BAR	LPM at 4.8 BAR	LPM at 5.5 BAR	LPM at 6.2 BAR	LPM at 6.9 BAR	LPM at 7.6 BAR	LPM at 8.3 BAR	LPM at 9.0 BAR
56.8	859*	821*	757	662	556	454	329			
60.6	874*	848*	803	719	617	515	420	314		
64.4	882*	863*	833*	776	678	572	473	379	280	185

9314C-M16, 9314CU-M16, 9314S-M16, 9314SU-M16

U.S. UNITS

Hyd. Flow GPM	GPM at 40 PSI	GPM at 50 PSI	GPM at 60 PSI	GPM at 70 PSI	GPM at 80 PSI	GPM at 90 PSI	GPM at 100 PSI	GPM at 110 PSI	GPM at 120 PSI	GPM at 130 PSI
18	216	191	155	100	30					
20	232*	224*	203	175	135	78				
22	232*	230*	224*	211	187	153	107	51		
24	232*	230*	226*	222*	212	190	162	126	85	34

9314C-M16, 9314CU-M16, 9314S-M16, 9314SU-M16

METRIC UNITS

Hyd. Flow LPM	LPM at 2.8 BAR	LPM at 3.4 BAR	LPM at 4.1 BAR	LPM at 4.8 BAR	LPM at 5.5 BAR	LPM at 6.2 BAR	LPM at 6.9 BAR	LPM at 7.6 BAR	LPM at 8.3 BAR	LPM at 9.0 BAR
68.1	818	723	587	379	114					
75.7	878*	848*	768	662	511	295				
83.3	878*	871*	848*	799	708	579	405	193		
90.8	878*	871*	856*	840*	803	719	613	477	322	129

*Flow rates can only be achieved with sufficient NPSHA (Net Positive Suction Head Available), refer to OIPM for details.

9316 Series



UPGRADE OPTIONS

- ◆ Hydraulic motor includes a case drain for maximum motor life
 - Life Guard seals are the OEM standard
 - Chemical corrosion, pump cavitation, and abrasive wear are key factors in pump life
 - 316 Stainless Steel pumps provide superior chemical corrosion resistance, while maintaining material strength to prolong the life against abrasive wear
 - 316 Stainless Steel resists cavitation pitting of pumps, extending the wear life
 - Drop in replacements for cast iron pumps

FEATURES

- ◆ ForceField Technology is a superior wet seal technology that provides the ultimate protection for the mechanical seal and avoids costly downtime
- ◆ Protects the mechanical seal against common failures related to dry run and chemical bonding by using a barrier fluid to keep it cool and lubricated
- ◆ Actively maintains a pressure differential between the barrier fluid and the pumping solution, which results in longer life and worry free operation.
- ◆ Capable of flows up to 311 GPM (1177 LPM) and can produce up to 150 PSI (10.3 bar)
- ◆ Designed to be a drop-in replacement for standard Hypro hydraulically driven centrifugal pumps
- ◆ One year warranty covering pump, motor and seals
- ◆ Flanged connections need universal flange gasket and universal flange clamp

ORDERING INFORMATION

Part Number	Current Product Equivalent	Inlet/Outlet	Max GPM	Max LPM	Max PSI	Max Bar	Max Hyd. GPM	Max Hyd. LPM
9316C3U-M08	9306C-HM1C-3U	300 x 220 Universal Flange	286	1083	127	8.8	14	53
9316C3U-M10	9306C-HM5C-3U	300 x 220 Universal Flange	311	1177	150	10.3	18	68.1
9316C3U-M16	9306C-HM3C-3U	300 x 220 Universal Flange	307	1162	128	8.8	24	90.8
9316S3U-M08	9306S-HM1C-3U	300 x 220 Universal Flange	286	1083	127	8.8	14	53
9316S3U-M10	9306S-HM5C-3U	300 x 220 Universal Flange	311	1177	150	10.3	18	68.1
9316S3U-M16	9306S-HM3C-3U	300 x 220 Universal Flange	307	1162	128	8.8	24	90.8

Case Drain motor available - Add suffix "Y" (i.e. 9313CU-M08Y)

9316 Series

9316C3U-M08, 9316S3U-M08

U.S. UNITS

Hyd. Flow GPM	GPM at 30 PSI	GPM at 40 PSI	GPM at 50 PSI	GPM at 60 PSI	GPM at 70 PSI	GPM at 80 PSI	GPM at 90 PSI	GPM at 100 PSI	GPM at 110 PSI	GPM at 120 PSI
11	250	213	175	131	86	40				
12	266*	232	194	154	116	82	48			
13	274*	243	207	174	140	109	78	48		
14	286*	262*	230	196	166	134	104	76	49	20

9316C3U-M08, 9316S3U-M08

METRIC UNITS

Hyd. Flow LPM	LPM at 2.1 BAR	LPM at 2.8 BAR	LPM at 3.4 BAR	LPM at 4.1 BAR	LPM at 4.8 BAR	LPM at 5.5 BAR	LPM at 6.2 BAR	LPM at 6.9 BAR	LPM at 7.6 BAR	LPM at 8.3 BAR
41.6	946	806	662	496	326	151				
45.4	1007*	878	734	583	439	310	182			
49.2	1037*	920	784	659	530	413	295	182		
53.0	1083*	992*	871	742	628	507	394	288	185	76

9316C3U-M10, 9316S3U-M10

U.S. UNITS

Hyd. Flow GPM	GPM at 30 PSI	GPM at 40 PSI	GPM at 50 PSI	GPM at 60 PSI	GPM at 70 PSI	GPM at 80 PSI	GPM at 90 PSI	GPM at 100 PSI	GPM at 110 PSI	GPM at 120 PSI	GPM at 130 PSI
15	298*	283*	255	223	189	151	108	65			
16	304*	295*	276*	247	212	175	139	104	65	29	
17	307*	299*	284*	261*	229	197	162	130	98	67	35
18	311*	303*	291*	271*	242	210	178	150	121	93	62

9316C3U-M10, 9316S3U-M10

METRIC UNITS

Hyd. Flow LPM	LPM at 2.1 BAR	LPM at 2.8 BAR	LPM at 3.4 BAR	LPM at 4.1 BAR	LPM at 4.8 BAR	LPM at 5.5 BAR	LPM at 6.2 BAR	LPM at 6.9 BAR	LPM at 7.6 BAR	LPM at 8.3 BAR	LPM at 9.0 BAR
56.8	1128*	1071*	965	844	715	572	409	246			
60.6	1151*	1117*	1045*	935	803	662	526	394	246	110	
64.4	1162*	1132*	1075*	988*	867	746	613	492	371	254	132
68.1	1177*	1147*	1102*	1026*	916	795	674	568	458	352	235

9316C3U-M16, 9316S3U-M16

U.S. UNITS

Hyd. Flow GPM	GPM at 30 PSI	GPM at 40 PSI	GPM at 50 PSI	GPM at 60 PSI	GPM at 70 PSI	GPM at 80 PSI	GPM at 90 PSI	GPM at 100 PSI	GPM at 110 PSI	GPM at 120 PSI
18	279*	249	210	164	94					
20	302*	290*	265*	231	190	128	35			
22	-	305*	299*	277*	243	202	151	91		
24	-	-	307*	301*	280*	252	217	177	130	63

9316C3U-M16, 9316S3U-M16

METRIC UNITS

Hyd. Flow LPM	LPM at 2.1 BAR	LPM at 2.8 BAR	LPM at 3.4 BAR	LPM at 4.1 BAR	LPM at 4.8 BAR	LPM at 5.5 BAR	LPM at 6.2 BAR	LPM at 6.9 BAR	LPM at 7.6 BAR	LPM at 8.3 BAR
68.1	1056*	943	795	621	356					
75.7	1143*	1098*	1003*	874	719	485	132			
83.3	-	1155*	1132*	1049*	920	765	572	344		
90.8	-	-	1162*	1139*	1060*	954	821	670	492	238

*Flow rates can only be achieved with sufficient NPSHA (Net Positive Suction Head Available), refer to OIPM for details.

9307C Series



FEATURES

- ◆ Hydraulic motor drive (for open center closed center and load-sensing systems)
- ◆ Port sizes: 3" NPT inlet, 2" NPT outlet
- ◆ 300 x 220 universal flange available (U)
- ◆ Max. fluid temperature: 140°F/60°C
- ◆ Impeller: stainless steel
- ◆ Motor: external gear
- ◆ Hydraulic ports: -10 SAE inlet and -12 SAE outlet
- ◆ Max. motor psi: 3000 (bar: 207)
- ◆ Pump seals: Life Guard silicon carbide standard
- ◆ Life Guard seals are the industry standard on OEM equipment
- ◆ Weight: 86 lbs./39 kg
- ◆ Flanged connections need universal flange gasket and universal flange clamp

ORDERING INFORMATION

Model Number	Max GPM	Max LPM	Max PSI	Max BAR	Max Hyd. GPM	Max Hyd. LPM	Hydraulic Selection System
9307C-GM10	370	1400	135	9.3	20	75.7	Open/Closed
9307C-GM12	370	1400	135	9.3	23	87.1	Open/Closed
3430-0604	Life Guard silicon carbide seal kit						
9307CX	Pump head only, no hydraulic motor						

*Universal Flange (300 x 220) - Add Suffix "U" (i.e.: 9307C-GM10-U)

9307C-GM10, 9307C-GM10-U

U.S. UNITS

Hyd. Flow GPM	GPM at 30 PSI	GPM at 40 PSI	GPM at 50 PSI	GPM at 60 PSI	GPM at 70 PSI	GPM at 80 PSI	GPM at 90 PSI	GPM at 100 PSI	GPM at 110 PSI
16	282	253	219	168	73				
17	318	288	258	222	174	95			
18	346	318	291	258	222	166	90		
19	361	361	338	311	281	250	201	137	
20	370	370	351	328	301	275	241	184	106

9307C-GM10, 9307C-GM10-U

METRIC UNITS

Hyd. Flow LPM	LPM at 2.1 BAR	LPM at 2.8 BAR	LPM at 3.4 BAR	LPM at 4.1 BAR	LPM at 4.8 BAR	LPM at 5.5 BAR	LPM at 6.2 BAR	LPM at 6.9 BAR	LPM at 7.6 BAR
60.6	1067	958	829	636	276				
64.4	1204	1090	977	840	659	360			
68.1	1310	1204	1101	977	840	628	341		
71.9	1366	1366	1279	1177	1064	946	761	519	
75.7	1400	1400	1329	1241	1139	1041	912	696	401

9307C-GM12, 9307C-GM12-U

U.S. UNITS

Hyd. Flow GPM	GPM at 30 PSI	GPM at 40 PSI	GPM at 50 PSI	GPM at 60 PSI	GPM at 70 PSI	GPM at 80 PSI	GPM at 90 PSI	GPM at 100 PSI	GPM at 110 PSI
16	222	180	115						
17	246	212	166	92					
18	274	245	209	157	58				
19	302	272	242	203	150				
20	326	298	271	240	196	142			
21	345	324	297	269	238	194	140		
22		345	322	297	270	236	193	138	
23		370	344	323	299	273	235	194	137

9307C-GM12, 9307C-GM12-U

METRIC UNITS

Hyd. Flow LPM	LPM at 2.1 BAR	LPM at 2.8 BAR	LPM at 3.4 BAR	LPM at 4.1 BAR	LPM at 4.8 BAR	LPM at 5.5 BAR	LPM at 6.2 BAR	LPM at 6.9 BAR	LPM at 7.6 BAR
60.6	840	681	435						
64.4	931	802	628	348					
68.1	1037	927	791	594	220				
71.9	1143	1030	916	768	568				
75.7	1234	1128	1026	908	742	537			
79.5	1306	1226	1124	1018	901	734	530		
83.3		1306	1219	1124	1022	893	731	522	
87.1		1400	1302	1223	1132	1033	889	734	519

9307CWS Series



FEATURES

- ◆ ForceField seal technology to protect your pump against today's harshest application environments
- ◆ Components designed for today's high volume liquid fertilizer application on large capacity sprayers.
- ◆ 300 universal flange inlet x 220 universal flange outlet
- ◆ One-year warranty that includes pump, motor and seals
- ◆ Flanged connections need universal flange gasket and universal flange clamp

ORDERING INFORMATION

Model Number	Max GPM	Max LPM	Max PSI	Max BAR	Max Hyd. GPM	Max Hyd. LPM	Hydraulic Selection System
9307CWS-GM12	370	1400	135	9.3	23	87.1	Open/Closed
9307CWS-GM12-002 (NPT)	370	1400	135	9.3	23	87.1	Open/Closed
9307CWS-GM12-004 (90°)	370	1400	135	9.3	23	87.1	Open/Closed
9307CWS-GM12-005 (180°)	370	1400	135	9.3	23	87.1	Open/Closed
9307CWS-GM12-006 (270°)	370	1400	135	9.3	23	87.1	Open/Closed

9307CWS-GM12: PERFORMANCE IN WATER

U.S. UNITS

Hyd. Flow GPM	GPM at 30 PSI	GPM at 40 PSI	GPM at 50 PSI	GPM at 60 PSI	GPM at 70 PSI	GPM at 80 PSI	GPM at 90 PSI	GPM at 100 PSI	GPM at 110 PSI
16	222	180	115						
17	246	212	166	92					
18	274	245	209	157	58				
19	302	272	242	203	150				
20	326	298	271	240	196	142			
21	345	324	297	269	238	194	140		
22	345	345	322	297	270	236	193	138	
23	370	370	344	323	299	273	235	194	137

9307CWS-GM12: PERFORMANCE IN WATER

METRIC UNITS

Hyd. Flow LPM	LPM at 2.1 BAR	LPM at 2.8 BAR	LPM at 3.4 BAR	LPM at 4.1 BAR	LPM at 4.8 BAR	LPM at 5.5 BAR	LPM at 6.2 BAR	LPM at 6.9 BAR	LPM at 7.6 BAR
60.6	840	681	435						
64.4	931	802	628	348					
68.1	1037	927	791	594	220				
71.9	1143	1030	916	768	568				
75.7	1234	1128	1026	908	742	537			
79.5	1306	1226	1124	1018	901	734	530		
83.3	1306	1306	1219	1124	1022	893	731	522	
87.1	1400	1400	1302	1223	1132	1033	889	734	519

9307CWS-GM12: PERFORMANCE IN 28% LIQUID FERTILIZER

U.S. UNITS

Hyd. Flow GPM	GPM at 40 PSI	GPM at 50 PSI	GPM at 60 PSI	GPM at 70 PSI	GPM at 80 PSI	GPM at 90 PSI	GPM at 100 PSI	GPM at 110 PSI	GPM at 120 PSI	GPM at 130 PSI	GPM at 140 PSI
16	228	204	159	100							
17	234	219	190	147	49						
18	247	247	223	194	146	49					
19	255	255	239	221	191	151	55				
20	260	260	252	240	220	191	150	63			
21	260	260	254	248	237	224	196	159	87		
22	260	260	254	248	240	230	214	194	159	101	
23	260	260	254	249	249	242	237	227	211	174	133

9307CWS-GM12: PERFORMANCE IN 28% LIQUID FERTILIZER

METRIC UNITS

Hyd. Flow LPM	LPM at 2.8 BAR	LPM at 3.4 BAR	LPM at 4.1 BAR	LPM at 4.8 BAR	LPM at 5.5 BAR	LPM at 6.2 BAR	LPM at 6.9 BAR	LPM at 7.6 BAR	LPM at 8.3 BAR	LPM at 9.0 BAR	LPM at 9.7 BAR
60.6	863	772	602	379	-						
64.4	886	829	719	556	185						
68.1	935	935	844	734	553	185					
71.9	965	965	905	836	723	572	208				
75.7	984	984	954	908	833	723	568	238			
79.5	984	984	961	939	897	848	742	602	329		
83.3	984	984	961	939	908	871	810	734	602	382	
87.1	984	984	961	942	942	916	897	859	799	659	503

9308C Series



FEATURES

- ◆ 5" ANSI-flanged inlet x 4" ANSI-flanged outlet
- ◆ 316 stainless steel impeller for superior corrosion resistance
- ◆ 9308 versions include a two-piece shaft design with a 416 stainless steel wet end and hardened 8620 drive end for extended life
- ◆ Life Guard silicon carbide seal for premium abrasion resistance and dry-run protection
- ◆ Life Guard seals are the industry standard on OEM equipment

ORDERING INFORMATION

Model Number	Max GPM	Max LPM	Max PSI	Max BAR	Max Hyd GPM	Max Hyd LPM	Hydraulic Selection System
9308C-PM15	900	3407	58	4.0	16	60.6	Open/Closed
9308CX	Pump head only						
3430-0604	Life Guard silicon carbide seal kit						

9308C-PM15

U.S. UNITS

Hyd. Flow GPM	GPM at 10 PSI	GPM at 20 PSI	GPM at 30 PSI	GPM at 40 PSI	GPM at 50 PSI
8	430				
12	656	656	416		
16	900	900	900	778	607

9308C-PM15

METRIC UNITS

Hyd. Flow LPM	LPM at 0.7 BAR	LPM at 1.4 BAR	LPM at 2.1 BAR	LPM at 2.8 BAR	LPM at 3.5 BAR
30.3	1628				
45.7	2483	2483	1575		
60.6	3407	3407	3407	2945	2298

PAGE INTENTIONALLY BLANK

9400 Belt Drive Series



UPGRADE OPTIONS

- ◆ Increase dry-run and abrasive resistance with Life Guard Seals
 - Life Guard seals are the OEM standard
- ◆ Extend pump life with Stainless Steel
 - Chemical corrosion, pump cavitation, and abrasive wear are key factors in pump life
 - 316 Stainless Steel pumps provide superior chemical corrosion resistance, while maintaining material strength to prolong the life against abrasive wear
 - 316 Stainless Steel resists cavitation pitting of pumps, extending the wear life
 - Drop in replacements for cast iron pumps

FEATURES

- ◆ Available in cast iron, polypropylene and 316 stainless steel for extended pump life
- ◆ Drive: 12-groove belt
- ◆ Spring-loaded belt tensioner
- ◆ Stainless steel wear ring
- ◆ Stainless steel pump shaft, standard
- ◆ Port sizes: 9402 models - 1-1/4" NPT inlet, 1" NPT outlet; 9403 models - 1-1/2" NPT inlet, 1-1/4" NPT outlet
- ◆ 220 x 200 universal flange available (U)
- ◆ Max. fluid temperature: 140°F/60°C
- ◆ Impeller: Cast Iron models - Nylon; Poly & Stainless Steel models - Polypropylene
- ◆ Pump shaft rotation: Counter clockwise when looking at shaft end
- ◆ Pump seals: Viton®/ceramic standard; Life Guard silicon carbide (B) available
- ◆ Life Guard seals are the industry standard on OEM equipment
- ◆ Weight: 40-45 lbs./18.2-20.5 kg
- ◆ Flanged connections need universal flange gasket and universal flange clamp

ORDERING INFORMATION

Model Number	Max GPM	Max LPM	Max PSI	Max BAR	Max RPM	PTO Output
9402C-540	76	283	95	6.5	600	1-3/8" female, 6-spline shaft
9402C-540Q	76	283	95	6.5	600	1-3/8" 6-spline quick coupler
9402C-540S	76	283	95	6.5	600	1" (25.4 mm) solid shaft
9402C-1000	76	283	95	6.5	1000	1-3/8" female, 21-spline shaft
9402C-1000L	76	283	95	6.5	1000	1-3/4" female, 20-spline shaft
9402C-1000S	76	283	95	6.5	1000	1" (25.4 mm) solid shaft
9403C-540†	140	530	104	7.2	600	1-3/8" female, 6-spline shaft
9403C-540Q†	140	530	104	7.2	600	1-3/8" 6-spline quick coupler
9403C-540S†	140	530	104	7.2	600	1" (25.4 mm) solid shaft
9403C-1000†	140	530	104	7.2	1000	1-3/8" female, 21-spline shaft
9403C-1000-MTZ*	164	617	113	7.8	1000	38 mm female, 8-spline shaft
9403C-1000S†	140	530	104	7.2	1000	1" (25.4 mm) solid shaft
3430-0332	Seal and o-ring repair kit					
3430-0476	Seal, o-ring, belt and gasket repair kit for 540 rpm drives					
3430-0477	Seal, o-ring, belt and gasket repair kit for 1000 rpm drives					
3430-0589	Life Guard silicon carbide seal kit					
3430-0333	Seal and o-ring repair kit (polypropylene)					
3430-0478	Seal, o-ring, belt and gasket repair kit for 540 rpm drives (polypropylene)					
3430-0590	Life Guard silicon carbide seal kit (polypropylene)					

†Universal Flange (220 x 200) - Add Suffix "U" (i.e.: 9403C-1000S-U)
 Life Guard silicon carbide seal - Add suffix "B" (i.e.: 9402C-540-B)
 Available for order through Hypro-EU only (Cambridge, UK)

9402C-540

U.S. UNITS

RPM	GPM at 20 PSI	GPM at 30 PSI	GPM at 40 PSI	GPM at 50 PSI	GPM at 60 PSI	GPM at 70 PSI	GPM at 80 PSI	GPM at 90 PSI
450	61	58	50	36				
500	67	66	62	56	42			
540	71	71	70	65	58	44		
600	76	76	76	75	73	66	56	42

9403P-540

U.S. UNITS

RPM	GPM at 20 PSI	GPM at 30 PSI	GPM at 40 PSI	GPM at 50 PSI	GPM at 60 PSI	GPM at 70 PSI	GPM at 80 PSI
450	68	60	46	20			
500	74	70	60	48	22		
540	82	78	70	60	46		
600	91	88	79	72	64	58	38

9400 Belt Drive Series

9402C-540

METRIC UNITS

RPM	LPM at 1.4 BAR	LPM at 2.1 BAR	LPM at 2.8 BAR	LPM at 3.4 BAR	LPM at 4.1 BAR	LPM at 4.8 BAR	LPM at 5.5 BAR	LPM at 6.2 BAR
450	231	220	189	136				
500	254	250	235	212	159			
540	269	269	265	246	220	167		
600	288	288	288	284	276	250	212	159

9403P-540

METRIC UNITS

RPM	LPM at 1.4 BAR	LPM at 2.1 BAR	LPM at 2.8 BAR	LPM at 3.4 BAR	LPM at 4.1 BAR	LPM at 4.8 BAR	LPM at 5.5 BAR
450	257	227	174	76			
500	280	265	227	182	83		
540	310	295	265	227	174		
600	344	333	299	273	242	220	144

9402C-1000

U.S. UNITS

RPM	GPM at 20 PSI	GPM at 30 PSI	GPM at 40 PSI	GPM at 50 PSI	GPM at 60 PSI	GPM at 70 PSI	GPM at 80 PSI	GPM at 90 PSI	GPM at 100 PSI
800	68	67	64	57	41				
900	74	74	73	71	64	54	41		
1000	76	76	76	76	76	72	65	56	43

9403P-1000

U.S. UNITS

RPM	GPM at 20 PSI	GPM at 30 PSI	GPM at 40 PSI	GPM at 50 PSI	GPM at 60 PSI	GPM at 70 PSI	GPM at 80 PSI
800	73	66	58	42			
900	82	78	70	60	46		
1000	86	86	79	72	64	58	38

9402C-1000

METRIC UNITS

RPM	LPM at 1.4 BAR	LPM at 2.1 BAR	LPM at 2.8 BAR	LPM at 3.4 BAR	LPM at 4.1 BAR	LPM at 4.8 BAR	LPM at 5.5 BAR	LPM at 6.2 BAR	LPM at 6.9 BAR
800	257	254	242	216	155				
900	280	280	276	269	242	204	155		
1000	288	288	288	288	288	273	246	212	163

9403P-1000

METRIC UNITS

RPM	LPM at 1.4 BAR	LPM at 2.1 BAR	LPM at 2.8 BAR	LPM at 3.4 BAR	LPM at 4.1 BAR	LPM at 4.8 BAR	LPM at 5.5 BAR
800	276	250	220	159			
900	310	295	265	227	174		
1000	326	326	299	273	242	220	144

9403C-540, 9403S-540

U.S. UNITS

RPM	GPM at 20 PSI	GPM at 30 PSI	GPM at 40 PSI	GPM at 50 PSI	GPM at 60 PSI	GPM at 70 PSI	GPM at 80 PSI	GPM at 90 PSI	GPM at 100 PSI
450	107	99	86	50					
500	121	116	106	93	76	42			
540	129	127	120	111	98	80	50		
600	140	138	135	130	121	112	94	73	40

9403C-540, 9403S-540

METRIC UNITS

RPM	LPM at 1.4 BAR	LPM at 2.1 BAR	LPM at 2.8 BAR	LPM at 3.4 BAR	LPM at 4.1 BAR	LPM at 4.8 BAR	LPM at 5.5 BAR	LPM at 6.2 BAR	LPM at 6.9 BAR
450	405	375	326	189					
500	458	439	401	352	288	159			
540	488	481	454	420	371	303	189		
600	530	522	511	492	458	424	356	276	151

9403C-1000, 9403S-1000

U.S. UNITS

RPM	GPM at 20 PSI	GPM at 30 PSI	GPM at 40 PSI	GPM at 50 PSI	GPM at 60 PSI	GPM at 70 PSI	GPM at 80 PSI	GPM at 90 PSI	GPM at 100 PSI
800	115	106	96	80	56				
900	129	127	120	111	98	80	50		
1000	140	139	137	133	128	119	100	76	46

9403C-1000, 9403S-1000

METRIC UNITS

RPM	LPM at 1.4 BAR	LPM at 2.1 BAR	LPM at 2.8 BAR	LPM at 3.4 BAR	LPM at 4.1 BAR	LPM at 4.8 BAR	LPM at 5.5 BAR	LPM at 6.2 BAR	LPM at 6.9 BAR
800	435	401	363	303	212				
900	488	481	454	420	371	303	189		
1000	530	526	519	503	485	450	379	288	174

9403C-1000-MTZ

U.S. UNITS

RPM	GPM at 10 PSI	GPM at 20 PSI	GPM at 30 PSI	GPM at 40 PSI	GPM at 50 PSI	GPM at 60 PSI	GPM at 70 PSI	GPM at 80 PSI	GPM at 90 PSI	GPM at 100 PSI	GPM at 110 PSI
800	136	132	123	112	98	70	45				
900	150	149	145	135	125	115	97	72	35		
1000	163	162	160	155	150	140	130	115	95	75	45

9403C-1000-MTZ

METRIC UNITS

RPM	LPM at 0.7 Bar	LPM at 1.4 Bar	LPM at 2.1 Bar	LPM at 2.8 Bar	LPM at 3.4 Bar	LPM at 4.1 Bar	LPM at 4.8 Bar	LPM at 5.5 Bar	LPM at 6.2 Bar	LPM at 6.9 Bar	LPM at 7.6 Bar
800	515	500	466	424	371	265	170				
900	568	564	549	511	473	435	367	273	132		
1000	617	613	606	587	568	530	492	435	360	284	170

GAS ENGINE-DRIVEN POWERPRO, CAST IRON

CENTRIFUGAL PUMPS

1521C-65 Models

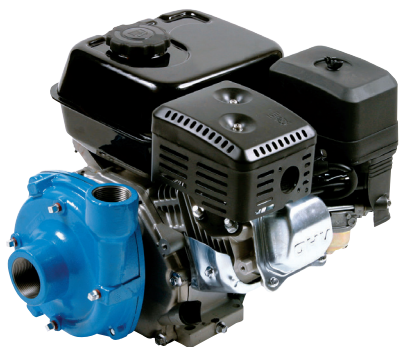

UPGRADE OPTIONS

- ◆ Increase dry-run and abrasive resistance with Life Guard Seals
 - Life Guard seals are the OEM standard

FEATURES

- ◆ PowerPro Engine
- ◆ Closed coupled, gas engine-driven
- ◆ Max. fluid temperature: 140°F/60°C
- ◆ Housing: cast iron
- ◆ Impeller: Nylon
- ◆ Pump seals: Viton®/ceramic standard; Life Guard silicon carbide available
- ◆ Life Guard seals are the industry standard on OEM equipment
- ◆ Weight: 65 lbs./29.4kg

ORDERING INFORMATION

Model Number	Max GPM	Max LPM	Max PSI	Max BAR	Port Size	Engine Mfg. & HP
1521C-65	110	416	80	5.5	1-1/2" x 1-1/4"	PowerPro 6.5 HP
1538	1-1/2" x 1-1/4" centrifugal pump. DOES NOT include Engine. (must use 5/8" threaded shaft engine)					
3430-0332	Seal and o-ring repair kit					
3430-0589	Life Guard silicon carbide seal kit					

1521C-65

U.S. UNITS

GPM at 10 PSI	GPM at 20 PSI	GPM at 30 PSI	GPM at 40 PSI	GPM at 50 PSI	GPM at 60 PSI	GPM at 70 PSI
110	106	96	88	80	60	30

1521C-65

METRIC UNITS

LPM at 0.7 BAR	LPM at 1.4 BAR	LPM at 2.1 BAR	LPM at 2.8 BAR	LPM at 3.4 BAR	LPM at 4.1 BAR	LPM at 4.8 BAR
416	401	363	333	303	227	114

GAS ENGINE-DRIVEN POWERPRO, CAST IRON

1522C-130E Models



FEATURES

- ◆ PowerPro Engine
- ◆ Closed coupled, gas engine-driven
- ◆ Max. fluid temperature: 140°F/60°C
- ◆ Housing: cast iron
- ◆ Impeller: Nylon
- ◆ Pump seals: Viton/ceramic standard
- ◆ Weight: 110 lbs./50kg

ORDERING INFORMATION

Model Number	Max GPM	Max (LPM)	Max PSI	Max BAR	Port Size	Engine Mfg. & HP
1552C-130E	170	644	150	10.3	2" x 1-1/2"	PowerPro 13 HP w/ electric start
1551	2" x 1-1/2" centrifugal pump kit. DOES NOT include engine. (must use 1" threaded shaft engine)					
3430-0464	Seal and o-ring repair kit					
3430-0779	Silicon carbide seal kit					

1552C-130E

U.S. UNITS

GPM at 20 PSI	GPM at 40 PSI	GPM at 60 PSI	GPM at 80 PSI	GPM at 100 PSI	GPM at 120 PSI	GPM at 140 PSI
170	166	148	120	92	65	35

1552C-130E

METRIC UNITS

LPM at 1.4 BAR	LPM at 2.8 BAR	LPM at 4.1 BAR	LPM at 5.5 BAR	LPM at 6.9 BAR	LPM at 8.3 BAR	LPM at 9.7 BAR
644	628	560	454	348	246	132

GAS ENGINE-DRIVEN, CAST IRON

CENTRIFUGAL PUMPS

1536 and 1539 Models

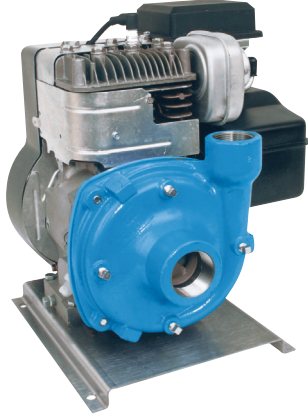

UPGRADE OPTIONS

- ◆ Increase dry-run and abrasive resistance with Life Guard Seals
 - Life Guard seals are the OEM standard

FEATURES

- ◆ Briggs & Stratton® engine
- ◆ Close-coupled, gas engine-driven
- ◆ Max. fluid temperature: 140°F/60°C
- ◆ Housing: cast iron
- ◆ Impeller: Nylon
- ◆ Pump seals: Viton®/ceramic standard; Life Guard silicon carbide available
- ◆ Life Guard seals are the industry standard on OEM equipment
- ◆ Weight: 53 lbs./24.1 kg

ORDERING INFORMATION

Model Number	Max GPM	Max LPM	Max PSI	Max BAR	Port Size	Engine Mfg. & HP
1536	110	416	75	5.2	1-1/2" x 1-1/4"	Briggs & Stratton® 5.5 HP
1539	Same as model 1536 without mounting base					
1538*	1-1/2" x 1-1/4" centrifugal pump kit. DOES NOT include engine. (must use 5/8" threaded shaft engine)					
3430-0332	Seal and o-ring repair kit					
3430-0589	Life Guard silicon carbide seal kit					

* Must use 5/8" threaded shaft engine.

1536, 1539

U.S. UNITS

GPM at 10 PSI	GPM at 20 PSI	GPM at 30 PSI	GPM at 40 PSI	GPM at 50 PSI	GPM at 60 PSI
110	106	96	87	73	50

1536, 1539

METRIC UNITS

LPM at 0.7 BAR	LPM at 1.4 BAR	LPM at 2.1 BAR	LPM at 2.8 BAR	LPM at 3.4 BAR	LPM at 4.1 BAR
416	401	363	329	276	189

Briggs & Stratton is a registered trademark of Briggs & Stratton Corporation.

GAS ENGINE-DRIVEN, CAST IRON

1537 and 1540 Models

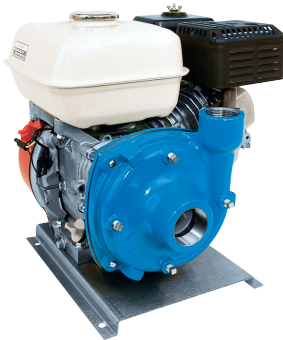

UPGRADE OPTIONS

- ◆ Increase dry-run and abrasive resistance with Life Guard Seals
 - Life Guard seals are the OEM standard

FEATURES

- ◆ Honda® engine
- ◆ Close-coupled, gas engine-driven
- ◆ Max. fluid temperature: 140°F/60°C
- ◆ Housing: cast iron
- ◆ Impeller: Nylon
- ◆ Pump seals: Viton/ceramic standard; Life Guard silicon carbide available
- ◆ Life Guard seals are the industry standard on OEM equipment
- ◆ Weight: 53 lbs./24.1 kg

ORDERING INFORMATION

Model Number	Max GPM	Max LPM	Max PSI	Max BAR	Port Size	Engine Mfg. & HP
1537	110	416	80	5.5	1-1/2" x 1-1/4"	Honda® 5.5 HP
1540	Same as model 1537 without mounting base					
1538*	1-1/2" x 1-1/4" centrifugal pump kit. DOES NOT include engine. (must use 5/8" threaded shaft engine)					
3430-0332	Seal and o-ring repair kit					
3420-0589	Life Guard silicon carbide seal kit					

* Must use 5/8" threaded shaft engine.

1537, 1540

U.S. UNITS

GPM at 10 PSI	GPM at 20 PSI	GPM at 30 PSI	GPM at 40 PSI	GPM at 50 PSI	GPM at 60 PSI	GPM at 70 PSI
110	106	96	88	80	60	30

1537, 1540

METRIC UNITS

LPM at 0.7 BAR	LPM at 1.4 BAR	LPM at 2.1 BAR	LPM at 2.8 BAR	LPM at 3.4 BAR	LPM at 4.1 BAR	LPM at 4.8 BAR
416	401	363	333	303	227	114

GAS ENGINE-DRIVEN, CAST IRON, SELF-PRIMING

CENTRIFUGAL PUMPS

1536-SP Models



UPGRADE OPTIONS

- ◆ Increase dry-run and abrasive resistance with Life Guard Seals
 - Life Guard seals are the OEM standard

FEATURES

- ◆ Briggs & Stratton® engine
- ◆ Max. fluid temperature: 140°F/60°C
- ◆ Housing: cast iron
- ◆ Impeller: Nylon
- ◆ Pump seals: Viton®/ceramic standard; Life Guard silicon carbide available
- ◆ Life Guard seals are the industry standard on OEM equipment
- ◆ Fill Port 3/4" NPT
- ◆ Weight: 72 lbs./32.7 kg

ORDERING INFORMATION

Model Number	Max GPM	Max LPM	Max PSI	Max BAR	Port Size	Engine Mfg. & HP
1536-SP	100	379	65	4.5	2" x 2"	Briggs & Stratton® 5.5 HP
1538-SP*	2" x 2" centrifugal pump kit. DOES NOT include engine. (must use 5/8" threaded shaft engine)					
3430-0332	Seal kit standard					
3430-0589	Life Guard silicon carbide seal kit					

* Must use 5/8" threaded shaft engine.

1536-SP

U.S. UNITS					
GPM at 10 PSI	GPM at 20 PSI	GPM at 30 PSI	GPM at 40 PSI	GPM at 50 PSI	GPM at 60 PSI
92	81	67	55	40	15

1536-SP

METRIC UNITS					
LPM at 0.7 BAR	LPM at 1.4 BAR	LPM at 2.1 BAR	LPM at 2.8 BAR	LPM at 3.4 BAR	LPM at 4.1 BAR
348	307	254	208	151	57

Briggs & Stratton is a registered trademark of Briggs & Stratton Corporation.

GAS ENGINE-DRIVEN, CAST IRON, SELF-PRIMING

1537-SP Models

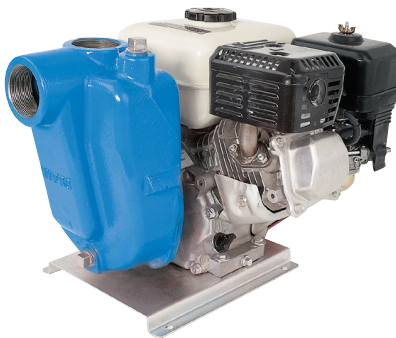

UPGRADE OPTIONS

- Increase dry-run and abrasive resistance with Life Guard Seals
 - Life Guard seals are the OEM standard

FEATURES

- ◆ Honda® engine
- ◆ Max. fluid temperature: 140°F/60°C
- ◆ Housing: cast iron
- ◆ Impeller: Nylon
- ◆ Pump seals: Viton/ceramic standard; Life Guard silicon carbide available
- ◆ Life Guard seals are the industry standard on OEM equipment
- ◆ Fill Port 3/4" NPT
- ◆ Weight: 78 lbs./35 kg

ORDERING INFORMATION

Model Number	Max GPM	Max LPM	Max PSI	Max BAR	Port Size	Engine Mfg. & HP
1537-SP	106	401	75	5.2	2" x 2"	Honda® 5.5 HP
1538-SP*	2" x 2" centrifugal pump kit. DOES NOT include engine. (must use 5/8" threaded shaft engine)					
3430-0332	Seal kit standard					
3430-0589	Life Guard silicon carbide seal kit					

* Must use 5/8" threaded shaft engine.

1537-SP

U.S. UNITS					
GPM at 10 PSI	GPM at 20 PSI	GPM at 30 PSI	GPM at 40 PSI	GPM at 50 PSI	GPM at 60 PSI
98	87	73	60	44	21

1537-SP

METRIC UNITS					
LPM at 0.7 BAR	LPM at 1.4 BAR	LPM at 2.1 BAR	LPM at 2.8 BAR	LPM at 3.4 BAR	LPM at 4.1 BAR
371	329	276	227	167	79

1550 Series

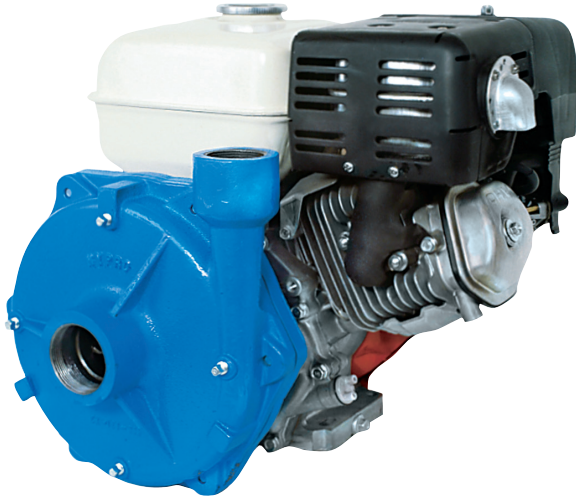

FEATURES

- ◆ Honda® engine
- ◆ Close-coupled, gas engine-driven
- ◆ Max. fluid temperature: 140°F/60°C
- ◆ Housing: cast iron
- ◆ Pump seals: Viton®/ceramic
- ◆ Impeller: Nylon
- ◆ Weight: 105 lbs./47.7 kg; SP and BSP: 125 lbs./56.8 kg

ORDERING INFORMATION

Model Number	Max GPM	Max LPM	Max PSI	Max BAR	Port Size	Engine Mfg. & HP	Self Priming
1550	150	568	140	9.7	2" x 1-1/2"	Honda 9 HP	No
1550-SP	155	587	135	9.3	2" x 2"	Honda 9 HP	Yes
1550-BSP†	155	587	135	9.3	2" x 2"	Honda 9 HP	Yes
1551*	2" x 1-1/2" centrifugal pump kit. DOES NOT include engine. (must use 1" threaded shaft engine)						
1551-SP*	2" x 2" centrifugal pump kit. DOES NOT include engine. (must use 1" threaded shaft engine)						
3430-0464	Seal, o-ring, and gasket repair kit						
3430-0779	Life Guard silicon carbide seal kit						

* Must use 1" threaded shaft engine. † BSP Threads

1550

U.S. UNITS

GPM at 20 PSI	GPM at 40 PSI	GPM at 60 PSI	GPM at 80 PSI	GPM at 100 PSI	GPM at 120 PSI	GPM at 140 PSI
145	130	107	87	69	45	16

1550

METRIC UNITS

LPM at 1.4 BAR	LPM at 2.8 BAR	LPM at 4.1 BAR	LPM at 5.5 BAR	LPM at 6.9 BAR	LPM at 8.3 BAR	LPM at 9.7 BAR
549	492	405	329	261	170	61

1550-SP, 1550-BSP

U.S. UNITS

GPM at 10 PSI	GPM at 20 PSI	GPM at 40 PSI	GPM at 60 PSI	GPM at 80 PSI	GPM at 100 PSI	GPM at 120 PSI
145	141	118	93	71	49	28

1550-SP, 1550-BSP

METRIC UNITS

LPM at 0.7 BAR	LPM at 1.4 BAR	LPM at 2.1 BAR	LPM at 2.8 BAR	LPM at 3.4 BAR	LPM at 4.1 BAR	LPM at 4.8 BAR
549	534	447	352	269	185	106

STANDARD

Industry tested and proven



COMMON USES

Less demanding applications; minimal dry run or abrasive solution

HOW IT WORKS

Mechanical seals depend on their seal face conditions of flatness and finish to maintain their sealing function while allowing the shaft to rotate. A spring ensures the seal faces stay in contact to prevent leaking. Elastomers are mated with adjacent shaft and housing components to complete the sealing system.

MATERIAL

Carbon on Ceramic

PRO

- ◆ Dependable life when protected from dry run and abrasives
- ◆ Least expensive option

CON

- ◆ Minimal dry run resistance
- ◆ Limited service life in abrasive solutions
- ◆ Susceptible to chemical & fertilizer bonding failures

LIFE GUARD

The OEM standard



COMMON USES

Suited for broad spraying applications including abrasive solutions

ADVANTAGES OVER STANDARD

The hardness of Silicon Carbide approaches that of diamond and allows the seal to have outstanding service life when pumping abrasive solutions. Carbon graphite flakes are embedded into the silicon carbide faces to increase lubricity and provide survivability against incidental dry run and thermal shock.

MATERIAL

Silicon Carbide

PRO

- ◆ Extended service life in abrasive solutions
- ◆ Enhanced dry run resistance
- ◆ Drop-in replacement for standard seal

CON

- ◆ Does not eliminate dry run failure
- ◆ Susceptible to chemical & fertilizer bonding failures
- ◆ Increased cost

FORCEFIELD TECHNOLOGY

The premium choice



COMMON USES

Applications where downtime must be avoided.

ADVANTAGES OVER LIFE GUARD

ForceField wet seal technology protects seals by using a barrier fluid to keep them cool and lubricated, even while the pump is running dry. ForceField technology actively maintains a positive pressure differential between the chamber barrier fluid and the pumping solution, which prevents chemical bonding of the seal faces. The result is increased life and maintenance free operation.

MATERIAL

Carbon on Silicon

PRO

- ◆ Eliminates dry run failure
- ◆ Prevent chemical & fertilizer bonding failures
- ◆ Maintenance-free operation
- ◆ Warranted for one full year

CON

- ◆ Increased cost

LIFE GUARD SILICON CARBIDE PUMP SEALS

CENTRIGUAL PUMPS

Specially designed to prolong seal life

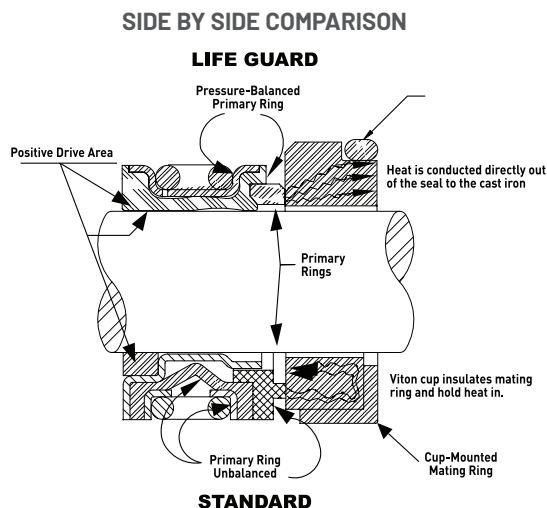

The drawing to the right represents a cross sectional view of a Life Guard Premium Silicon Carbide Seal (top) and a standard seal (bottom). There are three key differences shown in the drawing: material, mating rings and balance.

MATERIAL:

The Life Guard seal utilizes silicon carbide (SiC) for its seal surfaces (primary ring and mating ring). This is more abrasion resistant than the carbon graphite and ceramic used in standard seals. SiC also runs cooler if the pump is run dry, improving the life of the seal.

MATING RINGS:

The O-ring style of the Life Guard seal mating ring allows heat to dissipate into the pump casting. This keeps the seal at a lower temperature and dramatically improves the chances of the seal to survive a dry-run episode.

BALANCE:

The bellows and primary ring of the Life Guard seal are pressure balanced. This results in cooler operation at higher pressures.

Life Guard silicon carbide seals are available in the following models: Pedestal mount, Flange mount, Clutch-driven, Hydraulically-driven, Belt-driven, and Gas Engine-driven.

LIFE TEST IN ABRASIVE SOLUTION

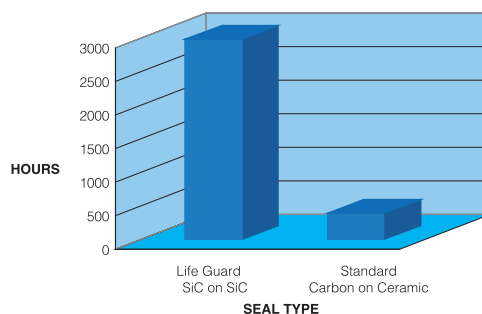

DRY-RUN SURVIVABILITY (5 MINUTES/CYCLE)

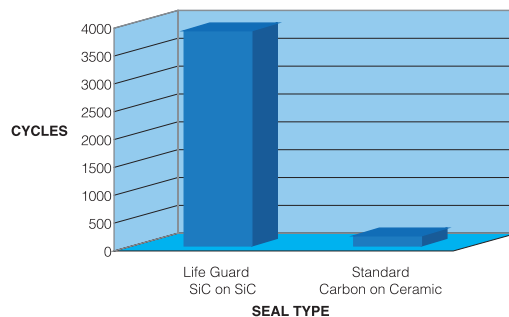

LIFE GUARD SILICON CARBIDE SEAL KITS

Part Number	Pump Series/Model #	Size		Description	Estimated Weight Ea.
		US	Metric		
3430-0589	9200, 9300 and 9400 Cast and Stainless	5/8"	15.9 mm	Mechanical seal and o-ring	4 oz./114 g
3430-0593	9303P	5/8"	15.9 mm	Mechanical seal, o-ring, gasket and washer for under acorn nut	4 oz./114 g
3430-0601	9305C and 9305C-SP	5/8"	15.9 mm	Mechanical seal and o-ring	4 oz./114 g
3430-0590	All Poly Models	3/4"	19 mm	Mechanical seal, o-ring, gasket and washer for under acorn nut	4 oz./114 g
3430-0604	9307 Series	1-3/8"	35 mm	Mechanical seal, o-ring and gasket	4 oz./114 g
3430-0646	9205 Models	3/4"	19 mm	Mechanical seal and o-ring	4 oz./114 g
3430-0591	9000C-0 and 9000C-0-SP	3/4"	19 mm	Mechanical seal and o-ring	4 oz./114 g

SELF-PRIMING ADAPTOR (SPA)

CENTRIGUAL PUMPS

Provides Fast Self-Priming for Closed Impeller Centrifugal Pumps



FEATURES

- ◆ Creates self-priming capability for all standard centrifugal pump models
- ◆ Increases priming efficiency over open impeller transfer pumps and self-priming centrifugal pumps
- ◆ Allows the use of a single, high efficiency pump for both tank filling and spraying
- ◆ Constructed out of 304 stainless steel for corrosion resistance
- ◆ Protects the pump's mechanical seal from dry-run during priming operations for on-board loading
- ◆ Guards against unexpected dry-run conditions during spraying application, if system were to function automatically
- ◆ Allows centrifugal pumps to be mounted in tight-fitting configurations while maintaining priming and flow performance capabilities
- ◆ SPA can be mounted in nearby remote location up to 10 ft (3 m) from pump

ORDERING INFORMATION

Model Number	Description
1530-0024S	2" NPT Self-Priming Adaptor
1530-0028S	2" NPT High Volume Self-Priming Adaptor
3430-0700	Mounting Kit

SELF-PRIMING ADAPTOR CONFIGURATION

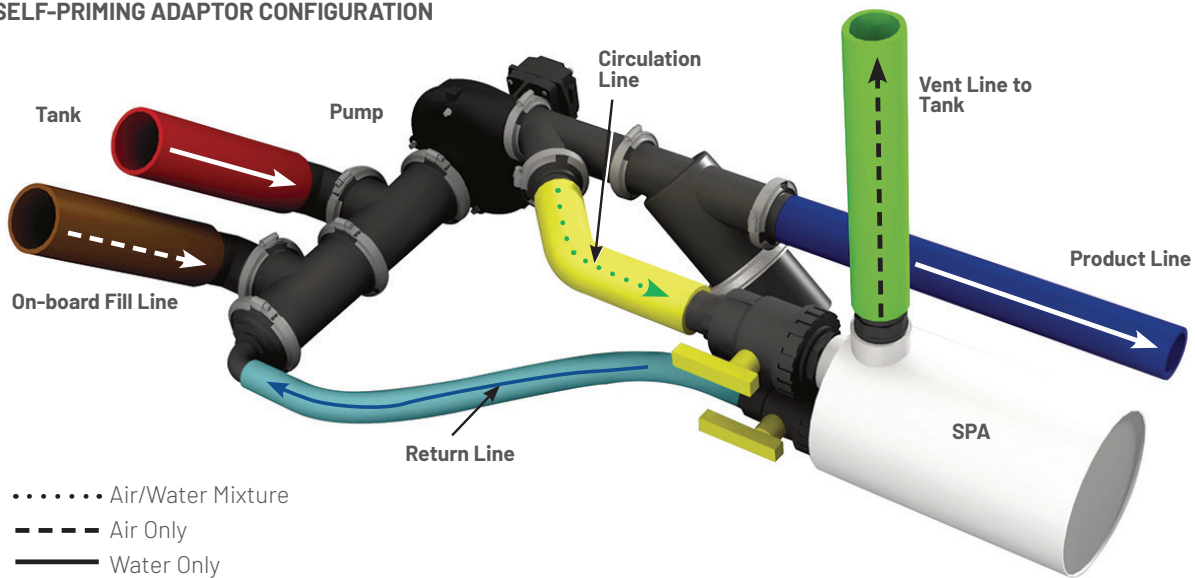

HOW THE SELF-PRIMING ADAPTOR WORKS

To facilitate pump priming, liquid is circulated through the pump and eye of the impeller. The attached Self-Priming Adaptor (SPA) stores an initial amount of liquid for the priming operation. The SPA, when activated with two ball valves, separates the air from the liquid being circulated and releases it back to the atmosphere through the vent line. Only liquid returns back to the pump inlet, thereby eliminating the inlet suction line of air. Once the pump is primed, pump pressure and flow increases. Flow is directed to the tank. The operator then closes the two ball valves, shutting off the circulation path between the pump and SPA.

FORCEFIELD REPLACEMENT FLUID

Part Number	Description
2160-0096	Replacement fluid (pre-mixed) for ForceField seal chamber- 23oz.

HYDRAULIC PORT ADAPTERS



Part Number	Description
3360-0021A	1/2" NPT Pressure Port Adapter
3430-0187	1/2" NPT Pressure Port Adapter with metering orifices
3320-0051A	3/4" NPT Tank Port Adapter
3320-0052A	SAE-10 (o-ring) Tank Port Adapter
3360-0023A	SAE-10 (o-ring) Pressure Port Adapter
3320-0077	M30x2.0 Pressure Port Adapter
3360-0027	M30x2.0 Tank Port Adapter

12 VOLT CLUTCH



Part Number	Shaft Size	Pulley Type	Max. HP	Max. RPM	Max. AMPS @ 12V	Pump Model	Est. Weight Ea.
2526-0011	7/8" (19 mm)	5.25" (140 mm)-A	30	5000	4.85	9203P-S, 9253P-C, 9205C, 9205C-SP	8 lbs./3.6kg
3430-0592	5/8" (15.9 mm)	5.00" (125 mm) Double Groove-A	30	5000	3.75	9202C, 9203C, 9206C, 9203C-R, 9262C-C, 9263C-C, 9263C-CR, 9203C-SP, 9263S-C, 9263S-CR, 9263C-C-SP	9 lbs./4.1kg

VENT LINE KIT



Part Number	Description	Est. Weight Ea.
3430-0456	Vent line kit with 25' (6.3 m) long, 1/4" ID vinyl hose, 1/8" NPT x 1/4" HB 90° nylon elbow fitting, 1/8" NPT x 1/4" HB straight polypropylene fitting, plastic hose clamp and plastic cable tie. Works with all Hypro centrifugals.	14 oz./397g
3430-0797	Push-to-connect vent line kit with 25' (6.3 m) long, 1/4" polyethylene tubing, 1/8" MNPT x 1/4" push-to-connect straight, 1/8" MNPT x 1/4" push-to-connect 90° elbow, and plastic cable ties. Works with all Hypro centrifugal pumps.	14 oz./397g

PTO MOUNTING CLIPS



Part Number	Pump Series	Est. Weight Ea.
1520-0034	9000C-0 (not for 9040 Series)	4 lbs./1.8 kg

CENTRIFUGAL PUMP REPAIR TOOLS



Part Number	Pump Series	Description
3010-0061	9000	Main bearing support tool
3010-0064	9000, 9200, 9300	Support bar/sleeve extractor
3010-0066	9200, 9300	Wire brush
3010-0067	9200, 9300	Wire brush holder
3010-0168	9000, 9200, 9300	Tool box
3020-0008	9300	Allen wrench; 1/4" hex
3020-0009	9200, 9300	Allen wrench; 1/16" hex

MATERIAL OPTIONS

ALUMINUM



TYPICAL USE:
Water Transfer

The aluminum construction does not lend itself well to chemical transfer.

OPTIONS INCLUDE:
2" and 3" semi-trash and 3" trash

CAST IRON



TYPICAL USE:
Liquid Fertilizer Transfer

Cast iron transfer pumps have thicker castings and stand up well to high density liquid fertilizers.

OPTIONS INCLUDE:
2" and 3" models available

POLYPROPYLENE



TYPICAL USE:
Chemical Transfer

Polypropylene has excellent corrosion resistance to virtually all Agricultural chemicals.

OPTIONS INCLUDE:
2" and 3" models available

DRIVE OPTIONS

GAS ENGINE



TYPICAL USE:
Outdoor applications in a mobile environment such as on a sprayer nurse/tender trailer.

HYDRAULIC MOTOR



TYPICAL USE:
Applications where a smaller footprint is desired and hydraulic power is available.

ELECTRIC MOTOR



TYPICAL USE:
Indoor and outdoor stationary applications where electrical power is available.

9243P Series



FEATURES

- ◆ Housing: 3" X 3" Polypropylene
- ◆ Pump Seals: EPDM Mechanical
- ◆ Suction lift: 25 ft./7.62 m
- ◆ Poly impeller with stainless steel insert
- ◆ 1" keyed shaft

ORDERING INFORMATION

Model Number	Max GPM	Max LPM	Max PSI	Max BAR	Port Size
9243P-SP	460	1741	54	3.7	3"x 3" NPT
3430-0692	Pump head kit with EPDM seal				
3430-0692-02	Pump head kit with EPDM seal and 3" UF Fittings				
3430-0757	EPDM seal kit				
3430-0838	Viton seal kit				
3410-0042	Cam lock kit				

9243P-SP

U.S. UNITS

	Feet	0	12	23	35	46	58	69	81	92	104	116
		PSI	0	5	10	15	20	25	30	35	40	45
2900 RPM	GPM	380	358	342	312	275	224	160	50	-	-	-
	HP	7.1	6.8	6.5	6.3	6.0	5.6	5.0	4.2	-	-	-
3200 RPM	GPM	424	405	384	359	331	297	251	193	103	0	-
	HP	9.1	8.9	8.7	8.5	8.3	8.0	7.5	7.0	6.2	5.3	-
3500 RPM	GPM	460	445	425	404	379	353	321	280	227	159	70
	HP	12.2	11.8	11.4	11.1	10.9	10.6	10.2	9.8	9.2	8.5	7.5

9243P-SP

METRIC UNITS

	m	5.1	10.2	12.8	15.3	17.9	20.4	23.0	25.5	28.1	30.6	33.2	35.7
		BAR	0.50	1.00	1.25	1.50	1.75	2.00	2.25	2.50	2.75	3.00	3.25
2900 RPM	LPM	1325	1193	1097	980	830	637	376	46	-	-	-	-
	kW	5.0	4.7	4.6	4.4	4.1	3.8	3.4	2.9	-	-	-	-
3200 RPM	LPM	1497	1378	1301	1215	1118	996	853	660	403	154	-	-
	kW	6.6	6.4	6.3	6.1	6.0	5.7	5.5	5.2	4.7	4.3	-	-
3500 RPM	LPM	1650	1537	1471	1403	1328	1242	1139	1016	866	685	467	208
	kW	8.7	8.3	8.2	8.0	7.9	7.7	7.5	7.2	6.9	6.5	6.0	5.5

1542P and 1543P Models



FEATURES

- ◆ Multiple gas engine options, including field proven Hypro PowerPro, Honda® and Hypro PowerPro and Honda engines (EPA & CARB certified - North America; EC/CE Listed - Europe)
- ◆ Housings: 2" x 2" Polypropylene or 3" x 3" polypropylene - highest performance available in a 3" transfer pump with highest efficiency and horsepower on the market
- ◆ Pump Seals: EPDM standard, Viton optional - contact factory
- ◆ Suction Lift: 25 ft./7.62 m
- ◆ Poly impeller with stainless steel insert (3"); Nylon impeller (2")
- ◆ 2" versions available with or without frame

2" GAS ENGINE-DRIVEN: ORDERING INFORMATION

Model Number	Max GPM	Max LPM	Max PSI	Max BAR	Port Size	Impeller Profile	Engine Mfg. & HP
1542P-65SP	200	757	58	4.0	2" x 2" NPT	5 vane	PowerPro 6.5 HP
1542P-65USP	200	757	58	4.0	2" x 2" Flange	5 vane	PowerPro 6.5 HP
1542P-65SPM	200	757	58	4.0	2" x 2" NPT	5 vane	PowerPro 6.5 HP with frame
1542P-65ESP	200	757	58	4.0	2" x 2" NPT	5 vane	PowerPro 6.5 HP w/ elec. start
1442P-65SP	200	757	58	4.0	2" x 2" NPT	5 vane	6.5 HP EC/CE listed
1542PV-65SP	200	757	58	4.0	2" x 2" w. Viton	5 vane	PowerPro 6.5 HP
1542P-950BSP	200	757	58	4.0	2" x 2"	5 vane	Briggs & Stratton 6.5HP
1542P-160HSP	200	757	58	4.0	2" x 2" NPT	5 vane	Honda GX160
1542P-160EHSP	200	757	58	4.0	2" x 2" NPT	5 vane	Honda GX160 w/ elec. start
1542P-160HUSP	200	757	58	4.0	2" x 2" Flange	5 vane	Honda GX160
1542P-200HSP	200	757	58	4.0	2" x 2" NPT	5 vane	Honda GX200
1542P-55SP	150	568	58	4.0	2" x 2" NPT	3 vane	PowerPro 6.5 HP
3410-0041	Cam lock kit						
3430-0690	Pump head kit for 1542P-55SP with EPDM seal (3 vane impeller)						
3430-0691	Pump head kit for 1542P-65SP with EPDM seal (5 vane impeller)						
3430-0946	Pump head kit for 1542P-65USP with 2" flanged ports.						
3430-0635	EPDM seal kit						
3430-0659	Viton seal kit						

POLYPROPYLENE, GAS ENGINE-DRIVEN, 2 IN. & 3 IN.

TRANSFER PUMPS

1542P and 1543P Models

2" GAS ENGINE-DRIVEN, CONTINUED

1542P-55SP

U.S. UNITS

GPM at 0 PSI	GPM at 10 PSI	GPM at 20 PSI	GPM at 30 PSI	GPM at 40 PSI	GPM at 50 PSI	GPM at 58 PSI
150	147	131	108	80	48	0

1542P-55SP

METRIC UNITS

LPM at 0 BAR	LPM at 0.7 BAR	LPM at 1.4 BAR	LPM at 2.1 BAR	LPM at 2.8 BAR	LPM at 3.4 BAR	LPM at 4.0 BAR
568	556	496	409	303	182	0

1542P-65SP, 1542P-200HSP, 1542P-16 0HSP, 1542P-160HUSP, 1542P-65USP

U.S. UNITS

GPM at 0 PSI	GPM at 10 PSI	GPM at 20 PSI	GPM at 30 PSI	GPM at 40 PSI	GPM at 50 PSI	GPM at 58 PSI
200	182	162	136	106	65	0

1542P-65SP, 1542P-200HSP, 1542P-160HSP, 1542P-160HUSP, 1542P-65USP

METRIC UNITS

LPM at 0 BAR	LPM at 0.7 BAR	LPM at 1.4 BAR	LPM at 2.1 BAR	LPM at 2.8 BAR	LPM at 3.4 BAR	LPM at 4.0 BAR
757	689	613	515	401	246	0

3" GAS ENGINE-DRIVEN: ORDERING INFORMATION

Model Number	Max GPM	Max LPM	Max PSI	Max BAR	Port Size	Impeller Profile	Engine Mfg. & HP
1543P-130SP	440	1666	54	3.7	3"x 3" NPT	5 vane	PowerPro 13 HP
1543P-130ESP	440	1666	54	3.7	3"x 3" NPT	5 vane	PowerPro 13 HP w/ elec. start
1543P-130ESP-01	440	1666	54	3.7	3"x3" FLANGE	5 vane	PowerPro 13 HP w/ elec. start
1543P-390EHSP	440	1666	54	3.7	3"x3" NPT	5 vane	Honda GX390 w/ elec. start
1543P-390EHUSP	440	1666	54	3.7	3"x3" FLANGE	5 vane	Honda GX390 w/ elec. start
3410-0042	Cam lock kit						
3430-0692	Pump head kit with EPDM seal						
3430-0692-02	Pump head kit with EPDM seal and 3" UF Fittings						
3430-0757	EPDM seal kit						
3430-0838	Viton seal kit						
3430-0943	EPDM Seal kit O rings and mechanical seal only						

1543P-130SP, 1543P-130ESP, 1543P-390EHSP, 1543P-130ESP-01

U.S. UNITS

GPM at 0 PSI	GPM at 10 PSI	GPM at 20 PSI	GPM at 30 PSI	GPM at 40 PSI	GPM at 50 PSI	GPM at 58 PSI
440	400	338	269	184	68	0

1543P-130SP, 1543P-130ESP, 1543P-390EHSP, 1543P-130ESP-01

METRIC UNITS

LPM at 0 BAR	LPM at 0.7 BAR	LPM at 1.4 BAR	LPM at 2.1 BAR	LPM at 2.8 BAR	LPM at 3.4 BAR	LPM at 4.0 BAR
1666	1514	1279	1018	697	257	0

9342P and 9343P Series



FEATURES

- ◆ Housing: 2"x2" or 3" X 3" Polypropylene
- ◆ Pump Seals: EPDM Mechanical
- ◆ Suction lift: 25 ft./7.62 m
- ◆ Poly impeller with stainless steel insert

2" HYDRAULICALLY-DRIVEN: ORDERING INFORMATION

Model Number	Max GPM	Max LPM	Max PSI	Max BAR	Port Size	Motor Capacity
9342P-HM1C-5SP	200	757	58	40	2" x 2" NPT	10 GPM
9342PV-HM1C-5SP	200	757	58	40	2" x 2" NPT w. Viton	10 GPM
9342P-HM1C-5USP	206	780	60	41	2" x 2" FLANGE	10 GPM
9342P-HM5C-5SP	206	780	60	41	2" x 2" NPT	11 GPM
9342P-HM5C-5USP	206	780	60	41	2" x 2" FLANGE	11 GPM
9342PV-HM5C-5SP	206	780	60	41	2" x 2" NPT w. Viton	11 GPM
3430-0690	Pump head kit for HM1C with EPDM seal					
3430-0691	Pump head kit for HM5C with EPDM seal					
3430-0946	Pump Head kit with 2" FLANGES EPDM seals					
3430-0635	EPDM seal kit					
3430-0659	Viton seal kit					
3410-0041	Cam lock kit					

9342P-HM1C-5SP

U.S. UNITS

Hyd. Flow GPM	GPM at 0 PSI	GPM at 10 PSI	GPM at 20 PSI	GPM at 30 PSI	GPM at 40 PSI	GPM at 50 PSI	GPM at 58 PSI
8	165	145	122	95	57		
9	185	166	144	119	86	0	
10	200	184	164	141	114	80	0

9342P-HM1C-5SP

METRIC UNITS

Hyd. Flow LPM	LPM at 0 BAR	LPM at 0.7 BAR	LPM at 1.4 BAR	LPM at 2.1 BAR	LPM at 2.8 BAR	LPM at 3.4 BAR	LPM at 4.0 BAR
30.3	625	549	463	358	215		
34.1	700	630	547	449	325	0	
37.9	757	695	620	534	433	301	0

9342P-HM5C-5SP

U.S. UNITS

Hyd. Flow GPM	GPM at 0 PSI	GPM at 10 PSI	GPM at 20 PSI	GPM at 30 PSI	GPM at 40 PSI	GPM at 50 PSI	GPM at 60 PSI
9	175	154	123	84	0		
10	192	174	149	118	76	0	
11	206	189	169	145	117	79	0

9342P-HM5C-5SP

METRIC UNITS

Hyd. Flow LPM	LPM at 0 BAR	LPM at 0.7 BAR	LPM at 1.4 BAR	LPM at 2.1 BAR	LPM at 2.8 BAR	LPM at 3.4 BAR	LPM at 4.1 BAR
34.1	662	582	467	316	0		
37.9	727	658	562	446	288	0	
41.6	780	717	639	550	442	299	0

POLYPROPYLENE, HYDRAULICALLY-DRIVEN, 2 IN & 3 IN.

TRANSFER PUMPS

9342P and 9343P Series

3" HYDRAULICALLY-DRIVEN: ORDERING INFORMATION

Model Number	Max GPM	Max LPM	Max PSI	Max BAR	Port Size	Engine Mfg. & HP
9343P-GM6-SP	450	1703	52	3.6	3"x 3" NPT	Hydraulic
9343P-GM6Y-SP*	450	1703	52	3.6	3"x 3" NPT	Hydraulic
9343P-GM10-SP	484	1832	58	4.0	3"x 3" NPT	Hydraulic
9343P-GM10Y-SP*	484	1832	58	4.0	3"x 3" NPT	Hydraulic
3430-0692	Pump head kit with EPDM seal					
3430-0692-02	Pump head kit with EPDM seal and 3" UF fittings					
3430-0757	EPDM seal kit					
3430-0838	Viton seal kit					
3410-0042	Cam lock kit					

* Y= case drain motor

9343P-GM6-SP

US UNITS

Performance	Feet	0	12	23	35	46	58	69	81	92	104	116	127
	PSI	0	5	10	15	20	25	30	35	40	45	50	55
8 gal/min	GPM	342	316	284	240	176	67	-	-	-	-	-	-
9 gal/min	GPM	378	355	327	294	252	194	103	-	-	-	-	-
10 gal/min	GPM	414	394	371	345	314	276	227	155	52	-	-	-
11 gal/min	GPM	450	433	414	392	368	340	307	265	210	128	28	-

9343P-GM6-SP

METRIC UNITS

Performance	m	5.1	10.2	12.8	15.3	17.9	20.4	23.0	25.5	28.1	30.6	33.2	35.7
	BAR	0.50	1.00	1.25	1.50	1.75	2.00	2.25	2.50	2.75	3.00	3.25	3.50
30 l/min	LPM	1110	885	730	495	145	165	-	-	-	-	-	-
35 l/min	LPM	1335	1180	1085	970	825	630	345	35	-	-	-	-
40 l/min	LPM	1545	1425	1355	1270	1185	1080	960	805	600	325	45	-

9343P-GM10-SP

US UNITS

Performance	Feet	0	12	23	35	46	58	69	81	92	104	116	127
	PSI	0	5	10	15	20	25	30	35	40	45	50	55
12 gal/min	GPM	364	340	310	274	227	157	46	-	-	-	-	-
13 gal/min	GPM	391	368	342	312	275	227	158	55	-	-	-	-
14 gal/min	GPM	415	395	373	348	318	282	236	170	74	-	-	-
15 gal/min	GPM	445	426	406	383	357	327	292	247	187	102	7	-
16 gal/min	GPM	484	466	446	425	401	374	344	309	266	211	139	47

9343P-GM10-SP

METRIC UNITS

Performance	m	5.1	10.2	12.8	15.3	17.9	20.4	23.0	25.5	28.1	30.6	33.2	35.7
	BAR	0.50	1.00	1.25	1.50	1.75	2.00	2.25	2.50	2.75	3.00	3.25	3.50
45 l/min	LPM	1225	1045	925	775	560	250	43	-	-	-	-	-
50 l/min	LPM	1390	1240	1150	1045	920	760	540	255	-24	-	-	-
55 l/min	LPM	1535	1405	1335	1255	1165	1060	935	780	575	310	35	-
60 l/min	LPM	1730	1610	1540	1470	1390	1305	1215	1105	985	840	665	445

9742P Series



FEATURES

- ◆ Available with either 5 HP or 7.5 HP 50/60 Hz TEFC Baldor electric motor
 - Three phase 230/460 volt motors in both 5 HP & 7.5 HP
 - Single phase 230 volt motor available in 5 HP
- ◆ Housing: 2" x 2" Polypropylene
- ◆ Pump Seals: EPDM Mechanical
- ◆ Suction Lift: 25ft/7.62m
- ◆ Nylon impeller

ORDERING INFORMATION: 50 HZ

Model Number	Max GPM	Max LPM	Max PSI	Max BAR	Port Size	Engine Mfg. & HP	Mounting Bolts
9742P-050SPT	120	454	32	2.2	2"x 2" NPT	Polypropylene	5/16" or M8
9742P-050SPT3	120	454	32	2.2	2"x 2" NPT	Polypropylene	5/16" or M8
9742P-075SPT3	160	606	37	2.6	2"x 2" NPT	Polypropylene	5/16" or M8

ORDERING INFORMATION: 60 HZ

Model Number	Max GPM	Max LPM	Max PSI	Max BAR	Port Size	Engine Mfg. & HP	Mounting Bolts
9742P-050SPT	150	568	47	3.2	2"x 2" NPT	Polypropylene	5/16" or M8
9742P-050SPT3	150	568	47	3.2	2"x 2" NPT	Polypropylene	5/16" or M8
9742P-075SPT3	188	712	54	3.7	2"x 2" NPT	Polypropylene	5/16" or M8

9742P-050SPT & 9742P-050SPT3

US UNITS

60 Hz	PSI	0	5	10	15	20	25	30	35	40	45	47
	GPM	150	142	133	123	111	97	84	66	43	9	0
50 Hz	PSI	0	5	10	15	20	25	30	32	-	-	-
	GPM	120	110	100	85	67	42	10	0	-	-	-

9742P-050SPT & 9742P-050SPT3

METRIC UNITS

60 Hz	BAR	0	0.3	0.7	1	1.4	1.7	2.1	2.4	2.8	3.1	3.2
	LPM	568	538	503	466	420	367	318	250	163	34	0
50 Hz	BAR	0	0.3	0.7	1	1.4	1.7	2.1	2.2	-	-	-
	LPM	454	416	379	322	254	159	38	0	-	-	-

9742P-075SPT3

US UNITS

60 Hz	PSI	0	5	10	15	20	25	30	35	40	45	50	54
	GPM	188	185	181	173	163	151	136	120	102	76	44	0
50 Hz	PSI	0	5	10	15	20	25	30	35	37	-	-	-
	GPM	160	155	143	129	112	90	65	20	0	-	-	-

9742P-075SPT3

METRIC UNITS

60 Hz	BAR	0	0.3	0.7	1	1.4	1.7	2.1	2.4	2.8	3.1	3.4	3.7
	LPM	712	700	685	655	617	572	515	454	386	288	167	0
50 Hz	BAR	0	0.3	0.7	1	1.4	1.7	2.1	2.4	2.6	-	-	-
	LPM	606	587	541	488	424	341	246	76	0	-	-	-

TRANSFER PUMPS ACCESSORIES

Transfer Pump Cam Lock Kit



FEATURES

- ◆ Hypro cam lock kits easily add heavy-duty male cam lock connections to the NPT ports of 2" and 3" polypropylene pumps.
- ◆ Includes one male cam lock adapter for pump inlet
- ◆ Includes one heavy-duty 90° elbow and one male cam lock adapter for the pump outlet
- ◆ Prepares transfer pumps for the most common means of quick coupling a hose
- ◆ Interchangeable with other cam lock fittings made to MIL-C-27487 specifications

ORDERING INFORMATION

Size	Model Number
2" NPT	3410-0041
3" NPT	3410-0042

1530 Series



1532C-6SP
with PowerPro Engine

FEATURES

- ◆ Gas engine driven
- ◆ Pump seals: fluoroelastomer (viton)
- ◆ Suction lift: 20 ft. (6 m)
- ◆ Flapper valve: EPDM
- ◆ Comes with silicon carbide mechanical seals, use optional carbon ceramic if pumping liquid fertilizer.

ORDERING INFORMATION

Model Number	Max GPM	Max LPM	Max PSI	Max BAR	Port Size	Engine Mfg. & HP
1532C-6SP	170	644	42	2.9	2" x 2" NPT	PowerPro 6.5 HP
1532C-160HSP	170	644	42	2.9	2" x 2" NPT	Honda GX160
1533C-13ESP	330	1249	60	4.1	3" x 3" NPT	PowerPro 13 HP w/ electric start
1533C-390EHSP	330	1249	60	4.1	3" x 3" NPT	Honda GX390 w/ electric start
3430-0673CSP	170	644	42	2.9	2" NPT	Pump head kit for 2" NPT self-priming cast iron transfer pump
3430-0674CSP	330	1249	60	4.1	3" NPT	Pump head kit for 3" NPT self-priming cast iron transfer pump
2120-0070	2" carbon ceramic mechanical seal					
2120-0071	3" carbon ceramic mechanical seal					

1532C-6SP, 1532C-160HSP

U.S. UNITS

GPM at 0 PSI	GPM at 5 PSI	GPM at 10 PSI	GPM at 15 PSI	GPM at 20 PSI	GPM at 25 PSI	GPM at 30 PSI	GPM at 35 PSI	GPM at 40 PSI	GPM at 42 PSI
170	155	140	123	106	87	65	42	14	0

1532C-6SP, 1532C-160HSP

METRIC UNITS

LPM at 0.0 BAR	LPM at 0.3 BAR	LPM at 0.7 BAR	LPM at 1.0 BAR	LPM at 1.4 BAR	LPM at 1.7 BAR	LPM at 2.1 BAR	LPM at 2.4 BAR	LPM at 2.8 BAR	LPM at 2.9 BAR
644	587	530	466	401	329	246	159	53	0

1533C-13ESP, 1533C-390EHSP

U.S. UNITS

GPM at 0 PSI	GPM at 5 PSI	GPM at 10 PSI	GPM at 15 PSI	GPM at 20 PSI	GPM at 25 PSI	GPM at 30 PSI	GPM at 35 PSI	GPM at 40 PSI	GPM at 45 PSI	GPM at 50 PSI	GPM at 60 PSI	GPM at 66 PSI
330	325	321	315	296	273	248	221	192	161	129	48	0

1533C-13ESP, 1533C-390EHSP

METRIC UNITS

LPM at 0.0 BAR	LPM at 0.3 BAR	LPM at 0.7 BAR	LPM at 1.0 BAR	LPM at 1.4 BAR	LPM at 1.7 BAR	LPM at 2.1 BAR	LPM at 2.4 BAR	LPM at 2.8 BAR	LPM at 3.1 BAR	LPM at 3.4 BAR	LPM at 4.1 BAR	LPM at 4.6 BAR
1249	1230	1215	1192	1120	1033	938	836	726	609	488	181	0

1530 Series



3430-0674CSP



9232C-SP

ORDERING INFORMATION

Model Number	Max GPM	Max LPM	Max PSI	Max BAR	Description
9232C-SP	170	644	42	2.9	2" x 2" NPT self priming pedestal-mount cast iron transfer pump (3/4" keyed shaft)
9233C-SP	330	1249	60	4.1	3" x 3" NPT self priming pedestal-mount cast iron transfer pump (1" keyed shaft)
3430-0673CSP	170	644	42	2.9	Pump head kit for 2" NPT self-priming cast iron transfer pump
3430-0674CSP	330	1249	60	4.1	Pump head kit for 3" NPT self-priming cast iron transfer pump
3430-0676					Replacement pedestal for 3" NPT self-priming cast iron transfer pump

9232C-SP, 3430-0673CSP

U.S. UNITS

GPM at 0 PSI	GPM at 5 PSI	GPM at 10 PSI	GPM at 15 PSI	GPM at 20 PSI	GPM at 25 PSI	GPM at 30 PSI	GPM at 35 PSI	GPM at 40 PSI	GPM at 42 PSI
170	155	140	123	106	87	65	42	14	0

9232C-SP, 3430-0673CSP

METRIC UNITS

LPM at 0.0 BAR	LPM at 0.3 BAR	LPM at 0.7 BAR	LPM at 1.0 BAR	LPM at 1.4 BAR	LPM at 1.7 BAR	LPM at 2.1 BAR	LPM at 2.4 BAR	LPM at 2.8 BAR	LPM at 2.9 BAR
644	587	530	466	401	329	246	159	53	0

9233C-SP, 3430-0674CSP

U.S. UNITS

GPM at 0 PSI	GPM at 5 PSI	GPM at 10 PSI	GPM at 15 PSI	GPM at 20 PSI	GPM at 25 PSI	GPM at 30 PSI	GPM at 35 PSI	GPM at 40 PSI	GPM at 45 PSI	GPM at 50 PSI	GPM at 60 PSI	GPM at 66 PSI
330	325	321	315	296	273	248	221	192	161	129	48	0

9233C-SP, 3430-0674CSP

METRIC UNITS

LPM at 0.0 BAR	LPM at 0.3 BAR	LPM at 0.7 BAR	LPM at 1.0 BAR	LPM at 1.4 BAR	LPM at 1.7 BAR	LPM at 2.1 BAR	LPM at 2.4 BAR	LPM at 2.8 BAR	LPM at 3.1 BAR	LPM at 3.4 BAR	LPM at 4.1 BAR	LPM at 4.6 BAR
1249	1230	1215	1192	1120	1033	938	836	726	609	488	181	0

ALUMINUM GAS ENGINE-DRIVEN, 2 IN. & 3 IN.

TRANSFER PUMPS

1540A Series



1543A-65TSP



1543A-65SP

FEATURES

- ◆ PowerPro Gas engine driven
- ◆ Housing: Aluminum
- ◆ Pump seals: EPDM Mechanical
- ◆ Suction lift: 13 ft./4m (1541A) & 23 ft./7.01m (1542A & 1543A)
- ◆ Trash pumps will handle 1-1/8" (29 mm) solids
- ◆ Transfer pumps will handle 3/8" (9.5mm) solids
- ◆ Framed: 1542A & 1543A versions only

ORDERING INFORMATION

Model Number	Max GPM	Max LPM	Max PSI	Max BAR	Port Size	Engine Mfg. & HP
1542A-65SP	147	556	50	3.4	2" x 2" NPT	PowerPro 6.5 HP
1542A-160HSP	147	556	50	3.4	2" x 2" NPT	Honda GX160
1543A-65SP	259	980	50	3.4	3" x 3" NPT	PowerPro 6.5 HP
1543A-160HSP	259	980	50	3.4	3" x 3" NPT	Honda GX160
1543A-65TSP (Trash)	272	1030	50	3.4	3" x 3" NPT	PowerPro 6.5 HP
1543A-160HTSP	272	1030	50	3.4	3" x 3" NPT	Honda GX160
3430-0791	3" Trash Kit (NPT ports, SAE 3/4" keyed shaft mount)					
3430-0792	2" Transfer Kit (NPT ports, SAE 3/4" keyed shaft mount)					
3430-0793	3" Transfer Kit (NPT ports, SAE 3/4" keyed shaft mount)					
3430-0802	Seal kit for 2" Transfer Pump					
3430-0803	Seal kit for 3" Transfer Pump					
3430-0801	Seal kit for 3" Trash Pump					

1542A-65SP, 1542A-160HSP

U.S. UNITS

GPM at 5 PSI	GPM at 10 PSI	GPM at 15 PSI	GPM at 20 PSI	GPM at 25 PSI	GPM at 30 PSI	GPM at 35 PSI	GPM at 40 PSI	GPM at 45 PSI	GPM at 50 PSI
147	144	136.6	124.7	110.2	94.1	78.3	57.1	19.2	0

1542A-65SP, 1542A-160HSP

METRIC UNITS

LPM at 0.3 BAR	LPM at 0.7 BAR	LPM at 1.0 BAR	LPM at 1.4 BAR	LPM at 1.7 BAR	LPM at 2.1 BAR	LPM at 2.4 BAR	LPM at 2.8 BAR	LPM at 3.1 BAR	LPM at 3.4 BAR
556.5	545.1	517.1	472	417.2	356.2	296.4	216.1	72.7	0

1543A-65SP, 1543A-160HSP

U.S. UNITS

GPM at 5 PSI	GPM at 10 PSI	GPM at 15 PSI	GPM at 20 PSI	GPM at 25 PSI	GPM at 30 PSI	GPM at 35 PSI	GPM at 40 PSI	GPM at 45 PSI	GPM at 50 PSI
259	251.6	233.7	213.6	190.9	162.2	135.8	99.3	56.1	8.7

1543A-65SP, 1543A-160HSP

METRIC UNITS

LPM at 0.3 BAR	LPM at 0.7 BAR	LPM at 1.0 BAR	LPM at 1.4 BAR	LPM at 1.7 BAR	LPM at 2.1 BAR	LPM at 2.4 BAR	LPM at 2.8 BAR	LPM at 3.1 BAR	LPM at 3.4 BAR
980.4	952.4	884.6	808.6	722.6	614	514.1	375.9	212.4	32.9

1543A-65TSP, 1543A-160HTSP

U.S. UNITS

GPM at 5 PSI	GPM at 10 PSI	GPM at 15 PSI	GPM at 20 PSI	GPM at 25 PSI	GPM at 30 PSI	GPM at 35 PSI	GPM at 40 PSI	GPM at 45 PSI	GPM at 50 PSI
272	269.8	241	207.6	179.3	140.4	98.1	50.7	5.4	0

1543A-65TSP, 1543A-160HTSP

METRIC UNITS

LPM at 0.3 BAR	LPM at 0.7 BAR	LPM at 1.0 BAR	LPM at 1.4 BAR	LPM at 1.7 BAR	LPM at 2.1 BAR	LPM at 2.4 BAR	LPM at 2.8 BAR	LPM at 3.1 BAR	LPM at 3.4 BAR
1029.6	1021.3	912.3	785.8	678.7	531.5	371.3	191.9	20.4	0

1570 Series



FEATURES

- ◆ Honda® engine
- ◆ Close-coupled, gas engine driven
- ◆ Housing: Aluminum
- ◆ Pump seals: Buna-N/ceramic
- ◆ Inlet valve: Buna-N
- ◆ Suction lift: 28 ft./8.53m

ORDERING INFORMATION

Model Number	Max GPM	Max LPM	Max PSI	Max BAR	Port Size	Engine Mfg. & HP
1572-SPX	145	549	50	3.4	2" x 2" NPT	Honda 4 HP
1573-SPX	280	1060	50	3.4	3" x 3" NPT	Honda 5.5 HP

1573-SPX

METRIC UNITS

LPM at 0.0 BAR	LPM at 0.3 BAR	LPM at 0.7 BAR	LPM at 1.0 BAR	LPM at 1.4 BAR	LPM at 1.7 BAR	LPM at 2.1 BAR	LPM at 2.4 BAR	LPM at 2.8 BAR	LPM at 3.1 BAR	LPM at 3.4 BAR
1060	1014	965	882	799	685	564	435	291	174	

1572-SPX

U.S. UNITS

GPM at 0 PSI	GPM at 5 PSI	GPM at 10 PSI	GPM at 15 PSI	GPM at 20 PSI	GPM at 25 PSI	GPM at 30 PSI	GPM at 35 PSI	GPM at 40 PSI	GPM at 45 PSI	GPM at 50 PSI
145	141	133	125	114	102	87	70	51	24	0

1572-SPX

METRIC UNITS

LPM at 0.0 BAR	LPM at 0.3 BAR	LPM at 0.7 BAR	LPM at 1.0 BAR	LPM at 1.4 BAR	LPM at 1.7 BAR	LPM at 2.1 BAR	LPM at 2.4 BAR	LPM at 2.8 BAR	LPM at 3.1 BAR	LPM at 3.4 BAR
549	534	503	473	432	386	329	265	193	91	

1573-SPX

U.S. UNITS

GPM at 0 PSI	GPM at 5 PSI	GPM at 10 PSI	GPM at 15 PSI	GPM at 20 PSI	GPM at 25 PSI	GPM at 30 PSI	GPM at 35 PSI	GPM at 40 PSI	GPM at 45 PSI	GPM at 50 PSI
280	268	255	233	211	181	149	115	77	46	0

SILVER SERIES XL*

NI-RESIST

CAST IRON

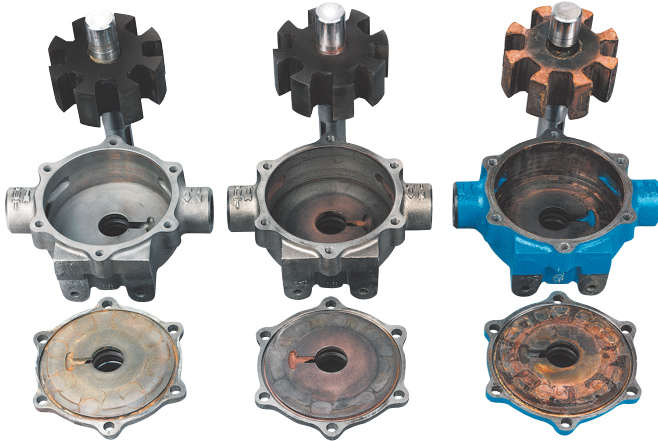

*Get up to 10 times longer pump life with Hypro Silver Series XL Roller pumps!

HERBICIDE USERS: GET UP TO 10 TIMES LONGER PUMP LIFE!

- ◆ Cast Iron pumps lasted to 140 hours before failure.
- ◆ Ni-Resist pumps lasted to 332 hours before failure.
- ◆ Silver Series X pumps ran over 1000 hours and still met new pump specs!

These three pump housings were photographed after being tested with a 30:1 mix of water and Roundup® herbicide.

The Ni-Resist and Cast Iron indicate damage from pitting and corrosion, but the Silver Series XL is in like-new condition after more than 1000 hours of use.

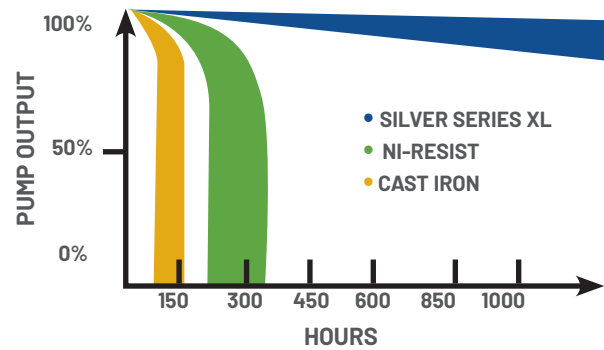

Floating Design, PTFE Coating



Ni-Resist Pumps

FLOATING PTFE COATED ROTORS

- ◆ Floating rotor design and black PTFE coating on metal rotors increases performance and extends pump life
- ◆ Standard production in 4001, 4101, 6500, & 7560 Silver Series XL and Ni-Resist pumps

CLEAR COAT FINISH

- ◆ Offers increased protection from chemical attack and from the elements
- ◆ Included on all Ni-Resist roller pumps

WHICH ROLLER PUMP, ROLLERS AND SEALS SHOULD YOU USE?

Material options for rollers and seals are listed in the order of recommendations for usage.

These recommendations are only a general guide. For suggestions on specific chemicals or applications, call Pentair's Technical/Applications Department at (800) 445-8360.

Application	Specific Chemicals	Suggestions							
		Housing Materials			Roller Materials			Seal Materials	
		Silver Series XL	Ni-Resist	Cast Iron	Super Roller	Poly Rollers	Teflon* Rollers*	Viton®	Buna-N
WEED CONTROL CHEMICALS	Emulsions, soluble powders, sodium arsenate.	X	X	X	X			X	
	Chemicals containing glyphosate (such as Roundup®) or other acidics	X			X	X	X*	X	
INSECT CONTROL	Emulsions not containing aromatic solvents.	X	X	X	X			X	
BRUSH CONTROL	Heavy-duty sprays using diesel oil for carrier.	X	X	X	X			X	
PEST CONTROL CHEMICALS, FUMIGANTS, ETC.	This category or use includes mosquito sprays, termite control liquids, nematocides, soil and grain fumigants where any of the following chemicals with aromatic solvents are present: Pentachlorophenol, xylene, xylol, benzene, high sulphur fuel or diesel oil. Fumigants containing: ethylene dichloride, ethylene dibromide, carbon tetrachloride, perchlorethylene, trichlorethylene, methyl bromide, and other aromatic solvents.	X	X	X	X			X	
LIQUID FERTILIZERS	Up to 32% nitrogen content, or others if the liquid is atmospheric pressure and the temperature is handled.	X	X			X		X	X
POWDERED FERTILIZERS	Fertilizers dissolved in water (greenhouse plant food).	X	X	X	X	X		X	X
PUMPING	Large quantities of plain water.	X	X	X	X	X		X	X
SPRAYING	Wettable powder sprays.	X	X	X	X	X		X	X
MATERIAL HANDLING	Heavy abrasive powders in suspension.	X	X	X	X	X		X	X
ACIDS	Mild sulfuric acid for spraying. Mild muriatic acid, inhibited muriatic, etc.	X				X	X*	X	

*Note: Limit Pressure at 100 psi (6.9 bar) when using Teflon Rollers.

CAST IRON, NI-RESIST OR SILVER SERIES XL

ROLLER PUMPS

4001 4 Roller Series



Pressure in PSI and BAR	GPM	HP	GPM	HP	GPM	HP
	LPM	HP	LPM	HP	LPM	HP
	@1100 RPM		@1400 RPM		@1800 RPM	
0 PSI	5.5	.06	7.1	.10	9.1	.14
0 BAR	20.8	.06	26.9	.10	34.4	.14
25 PSI	4.9	.14	6.4	.20	8.5	.30
1.7 BAR	18.5	.14	24.2	.20	32.2	.30
50 PSI	4.4	.24	5.9	.32	8.0	.46
3.4 BAR	16.6	.24	22.3	.32	30.3	.46
75 PSI	4.1	.34	5.6	.44	7.6	.62
5.2 BAR	15.5	.34	21.2	.44	28.7	.62
100 PSI	3.8	.41	5.3	.56	7.3	.78
6.9 BAR	14.4	.41	20.1	.56	27.6	.78
125 PSI	3.5	.50	5.0	.68	7.0	.95
8.6 BAR	13.2	.50	18.9	.68	26.5	.95
150 PSI	3.3	.62	4.8	.78	6.7	1.1
10.3 BAR	12.5	.62	18.2	.78	25.4	1.1

FEATURES

- ◆ Port size: 3/4" NPT
- ◆ Max. fluid temperature: 140°F/60°C
- ◆ Housing: Cast Iron (C), Ni-Resist (N) or Silver Series (XL)
- ◆ Pump shaft rotation: Clockwise when looking at the shaft end (counter clockwise available)
- ◆ Rollers: Super Rollers standard [Poly (T3) and Teflon® (T2)]
- ◆ Shaft Seals: Viton® standard
- ◆ Special torque arm and base kit is available for gas engines
- ◆ Rotor: Cast Iron, Ni-Resist or Silver Series
- ◆ Weight: 5 lbs./2.3 kg

ORDERING INFORMATION

Model Number	Max GPM	Max LPM	Max PSI	Max BAR	Max RPM	Shaft Output		
						U.S.	Metric	Shaft
4001C	9.1	34.4	150	10.3	1800	5/8"	15.9 mm	Solid
4001C-H	9.1	34.4	150	10.3	1800	1/2"	12.7 mm	Hollow
4001N	9.1	34.4	150	10.3	1800	5/8"	15.9 mm	Solid
4001N-H	9.1	34.4	150	10.3	1800	1/2"	12.7 mm	Hollow
4001XL	9.1	34.4	150	10.3	1800	5/8"	15.9 mm	Solid
4001XL-H	9.1	34.4	150	10.3	1800	1/2"	12.7 mm	Hollow

Teflon rollers - Add Suffix "T2" - (i.e.: 4001C-T2).
 Polypropylene rollers - Add Suffix "T3" - (i.e.: 4001C-T3).
 Reverse rotation* - Add Suffix "R" - (i.e.: 4001C-R).

CAST IRON, NI-RESIST OR SILVER SERIES XL

4101 4 Roller Series



Pressure in PSI and BAR	GPM	HP	GPM	HP	GPM	HP
	LPM	HP	LPM	HP	LPM	HP
	@1800 RPM		@2200 RPM		@2600 RPM	
0 PSI	5.0	.11	6.2	.14	7.2	.16
0 BAR	18.9	.11	23.5	.14	27.3	.16
25 PSI	4.8	.21	5.8	.27	6.9	.30
1.7 BAR	18.1	.21	21.9	.27	26.1	.30
50 PSI	4.5	.34	5.6	.40	6.6	.46
3.4 BAR	17.0	.34	21.2	.40	25.0	.46
75 PSI	4.2	.45	5.4	.55	6.4	.62
5.2 BAR	15.9	.45	20.4	.55	24.2	.62
100 PSI	3.9	.56	5.0	.68	6.0	.76
6.9 BAR	14.8	.56	18.9	.68	22.7	.76
125 PSI	3.7	.68	4.7	.82	5.7	.92
8.6 BAR	14.0	.68	17.8	.82	21.6	.92
150 PSI	3.4	.78	4.4	.96	5.4	1.08
10.3 BAR	12.9	.78	16.6	.96	20.4	1.08

FEATURES

- ◆ Port size: 3/4" NPT
- ◆ Max. fluid temperature: 140°F/60°C
- ◆ Housing: Cast Iron (C), Ni-Resist (N) or Silver Series (XL)
- ◆ Pump shaft rotation: Clockwise when looking at the shaft end (counter clockwise available)
- ◆ Rollers: Super Rollers standard [Poly (T3) and Teflon (T2)]
- ◆ Shaft Seals: Viton standard
- ◆ Special torque arm and base kit is available for gas engines
- ◆ Rotor: Cast Iron, Ni-Resist or Silver Series
- ◆ Weight: 5 lbs./2.27 kg

ORDERING INFORMATION

Model Number	Max GPM	Max LPM	Max PSI	Max BAR	Max RPM	Shaft Output		
						U.S.	Metric	Shaft
4101C	7.2	27.3	150	10.3	2600	5/8"	15.9 mm	Solid
4101C-H	7.2	27.3	150	10.3	2600	1/2"	12.7 mm	Hollow
4101N	7.2	27.3	150	10.3	2600	5/8"	15.9 mm	Solid
4101N-H	7.2	27.3	150	10.3	2600	1/2"	12.7 mm	Hollow
4101XL	7.2	27.3	150	10.3	2600	5/8"	15.9 mm	Solid
4101XL-H	7.2	27.3	150	10.3	2600	1/2"	12.7 mm	Hollow

Teflon rollers - Add Suffix "T2" - (i.e.: 4101C-T2).
 Polypropylene rollers - Add Suffix "T3" - (i.e.: 4101C-T3).
 Reverse rotation* -Add Suffix "R" - (i.e.: 4101C-R).

NI-RESIST OR SILVER SERIES XL

ROLLER PUMPS

4001 and 4101 12 volt DC 4 Roller Series



FEATURES

- ◆ Super Rollers and Viton® seals standard
- ◆ Locking collar and torque arm come in each package
- ◆ Rotor: Ni-Resist (N) or Silver Series (XL)
- ◆ Weight: 16-18 lbs./7.3-8.2 kg

Note: All models come in either Ni-Resist or Silver Series XL housings.

ORDERING INFORMATION

Model Number	Max GPM	Max LPM	Max PSI	Max BAR	Max RPM	Shaft Output		
						U.S	Metric	Shaft
4001N-EH	10.4	39.4	30	2.1	1900	1/2"	12.7 mm	Hollow
4001N-E2H	9.9	37.5	50	3.4	1600	1/2"	12.7 mm	Hollow
4001XL-EH	10.4	39.4	30	2.1	1900	1/2"	12.7 mm	Hollow
4001XL-E2H	9.9	37.5	50	3.4	1600	1/2"	12.7 mm	Hollow
4101N-EH	7.5	28.4	50	3.4	1900	1/2"	12.7 mm	Hollow
4101N-E2H	5.9	22.3	90	6.2	1600	1/2"	12.7 mm	Hollow
4101XL-EH	7.5	28.4	50	3.4	1900	1/2"	12.7 mm	Hollow
4101XL-E2H	5.9	22.3	90	6.2	1600	1/2"	12.7 mm	Hollow

Teflon® rollers - Add Suffix "T2" - (i.e.: 4001N-EHT2).

Polypropylene rollers - Add Suffix "T3" - (i.e.: 4001N-EHT3).

U.S. UNITS

METRIC UNITS

Series 4101-EH and 4101-E2H	Model 4101N-EH & 4101XL-EH				Model 4101N-E2H & 4101XL-E2H		
	Volts	PSI	AMPS	GPM	PSI	AMPS	GPM
12.0 (Battery) Engine Off	0	10.0	6.3	0	---	---	---
	5	11.3	6.0	10	8.4	5.3	
	10	12.5	5.8	20	11.8	4.8	
	15	13.7	5.6	30	13.7	4.65	
	20	15.1	5.4	40	16.4	4.4	
	25	16.7	5.2	50	19.6	4.05	
	30	18.6	5.0	60	22.8	3.65	
	35	20.3	4.8	70	25.8	3.20	
	40	22.3	4.6	80	28.9	3.00	
	45	24.1	4.4	90	31.5	2.75	
50	25.7	4.2	100	34.2	2.60		
13.5 (Alternator) Engine Running	0	10.4	7.5	0	---	---	---
	5	11.7	7.0	10	9.1	5.9	
	10	13.0	6.6	20	11.2	5.6	
	15	14.2	6.4	30	13.9	5.25	
	20	15.8	6.2	40	16.9	5.0	
	25	17.4	6.0	50	19.5	4.7	
	30	19.6	5.8	60	22.7	4.35	
	35	20.9	5.6	70	25.7	4.0	
	40	22.5	5.4	80	29.2	3.6	
	45	24.3	5.2	90	31.9	3.4	
50	26.1	5.0	100	34.8	3.2		

Series 4101-EH and 4101-E2H	Model 4101N-EH & 4101XL-EH				Model 4101N-E2H & 4101XL-E2H		
	Volts	BAR	AMPS	LPM	BAR	AMPS	LPM
12.0 (Battery) Engine Off	0	10.0	23.8	0	---	---	---
	.3	11.3	22.7	.7	8.4	20.0	
	.7	12.5	22.0	1.4	11.8	18.2	
	1.0	13.7	21.2	2.1	13.7	17.6	
	1.4	15.1	20.4	2.8	16.4	16.7	
	1.7	16.7	19.7	3.4	19.6	15.3	
	2.1	18.6	18.9	4.1	22.8	13.8	
	2.4	20.3	18.2	4.8	25.8	12.1	
	2.8	22.3	17.4	5.5	28.9	11.4	
	3.1	24.1	16.7	6.2	31.5	10.4	
3.4	25.7	15.9	6.9	34.2	9.84		
13.5 (Alternator) Engine Running	0	10.4	28.4	0	---	---	---
	.3	11.7	26.5	.7	9.1	22.3	
	.7	13.0	25.0	1.4	11.2	21.2	
	1.0	14.2	24.2	2.1	13.9	19.9	
	1.4	15.8	23.5	2.8	16.9	18.9	
	1.7	17.4	22.7	3.4	19.5	17.8	
	2.1	19.6	22.0	4.1	22.7	16.5	
	2.4	20.9	21.2	4.8	25.7	15.1	
	2.8	22.5	20.4	5.5	29.2	13.6	
	3.1	24.3	19.7	6.2	31.9	12.9	
3.4	26.1	18.9	6.9	34.8	12.1		

Series 4001-EH and 4001-E2H	Model 4001N-EH & 4001XL-EH				Model 4001N-E2H & 4001XL-E2H		
	Volts	PSI	AMPS	GPM	PSI	AMPS	GPM
12.0 (Battery) Engine Off	0	12.6	9.0	10	13.9	8.4	
	5	14.1	8.3	20	18.0	7.9	
	10	15.2	8.1	30	22.2	7.2	
	15	17.3	7.8	35	25.0	6.9	
	20	19.7	7.2	40	27.0	6.5	
	25	22.1	6.7	50	31.6	5.9	
	30	24.8	6.2	60	36.2	5.4	
13.5 (Alternator) Engine Running	0	13.4	10.4	10	14.4	9.9	
	5	14.8	9.9	20	18.3	9.1	
	10	16.2	9.4	30	22.3	8.5	
	15	18.2	8.9	35	24.5	8.3	
	20	20.5	8.5	40	27.0	8.0	
	25	22.5	8.2	50	31.0	7.3	
	30	24.9	7.7	60	36.1	6.8	

Series 4001-EH and 4001-E2H	Model 4001N-EH & 4001XL-EH				Model 4001N-E2H & 4001XL-E2H		
	Volts	BAR	AMPS	LPM	BAR	AMPS	LPM
12.0 (Battery) Engine Off	0	12.6	34.1	.7	13.9	31.8	
	.3	14.1	31.4	1.4	18.0	29.9	
	.7	15.2	30.7	2.1	22.2	27.3	
	1.0	17.3	29.5	2.4	25.0	26.1	
	1.4	19.7	27.3	2.8	27.0	24.6	
	1.7	22.1	25.4	3.5	31.6	22.3	
	2.1	24.8	23.5	4.1	36.2	20.4	
13.5 (Alternator) Engine Running	0	13.4	39.4	.7	14.4	37.5	
	.3	14.8	37.5	1.4	18.3	34.4	
	.7	16.2	35.6	2.1	22.3	32.2	
	1.0	18.2	33.7	2.4	24.5	31.4	
	1.4	20.5	32.2	2.8	27.0	30.3	
	1.7	22.5	31.0	3.5	31.0	27.6	
	2.1	24.9	29.1	4.1	36.1	25.7	

CAST IRON, NI-RESIST OR SILVER SERIES XL

ROLLER PUMPS

6500 6-Roller Series



Pressure in PSI and BAR	GPM	HP	GPM	HP	GPM	HP
	LPM	HP	LPM	HP	LPM	HP
	@540 RPM		@1000 RPM		@1200 RPM	
0 PSI	9.7	.08	18.2	.20	21.8	.30
0 BAR	36.7	.08	68.9	.20	82.5	.30
50 PSI	8.0	.38	16.5	.71	20.1	.90
3.4 BAR	30.3	.38	62.4	.71	76.1	.90
100 PSI	7.2	.68	15.4	1.26	19.1	1.51
6.9 BAR	27.3	.68	58.3	1.26	72.3	1.51
150 PSI	6.6	.97	14.7	1.80	18.2	2.14
10.3 BAR	25	.97	55.6	1.80	68.9	2.14
200 PSI	5.6	1.29	14.0	2.34	17.3	2.84
13.8 BAR	21.2	1.29	53	2.34	65.5	2.84
250 PSI	4.9	1.65	13.4	2.91	16.5	3.48
17.2 BAR	18.5	1.65	50.7	2.91	62.4	3.48
300 PSI	4.3	1.91	12.7	3.47	15.7	4.17
20.7 BAR	16.3	1.91	48.1	3.47	59.4	4.17

FEATURES

- ◆ Port size: 3/4" NPT
- ◆ 1" hose barb inlet fitting for 1000 rpm operation
- ◆ Max. fluid temperature: 140°F/60°C
- ◆ Housing: Cast Iron (C), Ni-Resist (N) or Silver Series (XL)
- ◆ Shaft rotation: Counter clockwise when looking at the shaft end (clockwise available)
- ◆ Rollers: Super Rollers standard [Poly (T3) and Teflon® (T2)]
- ◆ Shaft Seals: Viton® standard
- ◆ Available PTO adapters: See page 76
- ◆ Recommended PTO torque arm kit 3430-0540
- ◆ Rotor: Cast Iron, Ni-Resist or Silver Series
- ◆ Weight: 9 lbs./4.1 kg

ORDERING INFORMATION

Model Number	Max GPM	Max LPM	Max PSI	Max BAR	Max RPM	Shaft Output		
						U.S	Metric	Shaft
6500C	21.8	82.5	300	20.7	1200	5/8"	15.9 mm	solid
6500N	21.8	82.5	300	20.7	1200	5/8"	15.9 mm	solid
6500XL	21.8	82.5	300	20.7	1200	5/8"	15.9 mm	solid

Teflon® rollers - Add Suffix "T2" - (i.e.: 6500C-T2).
 Polypropylene rollers - Add Suffix "T3" - (i.e.: 6500C-T3).
 Reverse rotation* - Add Suffix "R" - (i.e.: 6500C-R).

CAST IRON, NI-RESIST OR SILVER SERIES XL

7560 8-Roller Series



Pressure in PSI and BAR	GPM	HP	GPM	HP	GPM	HP
	LPM	HP	LPM	HP	LPM	HP
	@540 RPM		@800 RPM		@1000 RPM	
0 PSI	12	.33	18.3	.89	22.5	1.56
0 BAR	45.4	.33	69.3	.89	85.2	1.56
50 PSI	11.1	.74	17.5	1.26	22	1.78
3.4 BAR	42	.74	66.2	1.26	83.3	1.78
100 PSI	10.3	1.25	16.9	1.95	21.3	2.53
6.9 BAR	39	1.25	64	1.95	80.6	2.53
150 PSI	9.5	1.77	16.1	2.65	20.6	3.5
10.3 BAR	36	1.77	60.9	2.65	78	3.5
200 PSI	8.6	2.26	15.5	3.4	20	4.2
13.8 BAR	32.5	2.26	58.7	3.4	75.7	4.2
250 PSI	7.0	2.78	14.5	4.2	18.9	5.3
17.2 BAR	29.5	2.78	54.9	4.2	71.5	5.3
300 PSI	7.1	3.3	18.9	5.3	18.0	6.1
20.7 BAR	26.9	3.3	51.9	5.3	68.1	6.1

FEATURES

- ◆ Max. fluid temperature: 140°F/60°C
- ◆ Port sizes: 3/4" NPT
- ◆ 1" hose barb inlet fitting for 1000 rpm operation
- ◆ Housing: Cast Iron (C), Ni-Resist (N) or Silver Series (XL)
- ◆ Shaft rotation: Counter clockwise when looking at the shaft end (clockwise available)
- ◆ Rollers: Super Rollers standard [Poly (T3) and Teflon® (T2)]
- ◆ Shaft Seals: Viton® standard
- ◆ Recommended PTO torque arm kit 3430-0540
- ◆ Rotor: Cast Iron, Ni-Resist or Silver Series
- ◆ Weight: 13 lbs./5.89 kg

ORDERING INFORMATION

Model Number	Max GPM	Max LPM	Max PSI	Max BAR	Max RPM	Shaft Output		
						U.S	Metric	Shaft
7560C	22.5	85.2	300	26.7	1000	15/16"	23.8 mm	Solid
7560N	22.5	85.2	300	26.7	1000	15/16"	23.8 mm	Solid
7560XL	22.5	85.2	300	26.7	1000	15/16"	23.8 mm	Solid

Teflon rollers - Add Suffix "T2" - (i.e.: 7560C-T2).
 Polypropylene rollers - Add Suffix "T3" - (i.e.: 7560C-T3).
 Reverse rotation* - Add Suffix "R" - (i.e.: 7560C-R).

7560-GM30, 7560-GM15 8-Roller Series

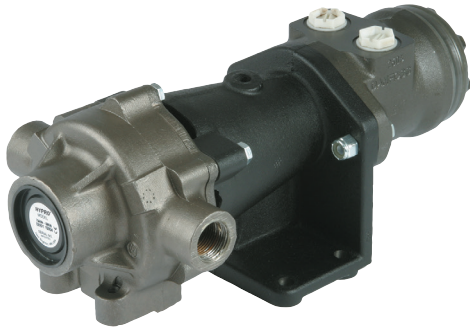

FEATURES

- ◆ Hydraulic motor drive (for open center, closed center and load-sensing systems)
- ◆ Max. fluid temperature: 140°F/60°C
- ◆ Pump port size: 3/4" NPT
- ◆ 1" hose barb inlet fitting for 1000 rpm operation
- ◆ Housing: Cast Iron (C), Ni-Resist (N) or Silver Series (XL)
- ◆ Rollers: Super Rollers standard [Poly (T3) and Teflon® (T2)]
- ◆ Shaft Seals: Viton® standard
- ◆ Rotor: Cast Iron, Ni-Resist or Silver Series
- ◆ Motor port size: -10 SAE (7/8"- 14" UNF)

ORDERING INFORMATION

Model Number	Max GPM	Max LPM	Max PSI	Max BAR	Max RPM	Motor Capacity Hydraulic Flow Max	
						US	Metric
7560C-GM30	20.8	78.7	300	20.7	1000	12 GPM	45 LPM
7560N-GM30	20.8	78.7	300	20.7	1000	12 GPM	45 LPM
7560XL-GM30	20.8	78.7	300	20.7	1000	12 GPM	45 LPM
7560N-GM15	20.1	76.1	300	20.7	1000	6 GPM	23 LPM
7560XL-GM15	20.1	76.1	300	20.7	1000	6 GPM	23 LPM

7560C,N,XL-GM15

U.S. UNITS

Hyd. GPM	GPM at									
	0 PSI	25 PSI	50 PSI	75 PSI	100 PSI	125 PSI	150 PSI	200 PSI	250 PSI	300 PSI
3	10.6	9.4	8.5	7.7	7.1	6.5	5.8	4.8	3.2	1.6
4	14.1	13.1	12.0	11.3	10.6	10.0	9.3	8.3	6.9	5.2
5	17.4	16.6	15.7	15.0	14.4	13.5	13.2	11.8	10.3	8.7
6	20.8	20.1	19.4	18.6	17.9	17.1	16.5	14.9	13.3	11.8

7560C,N,XL-GM15

METRIC UNITS

Hyd. LPM	LPM at									
	0 Bar	1.7 Bar	3.5 Bar	5.2 Bar	6.9 Bar	8.6 Bar	10.3 Bar	13.8 Bar	17.2 Bar	20.7 Bar
11.4	40.1	35.6	32.2	29.1	26.9	24.6	22.0	18.2	12.1	6.1
15.1	53.4	49.6	45.4	42.8	40.1	37.9	35.2	31.4	26.1	19.7
18.9	65.9	62.8	59.4	56.8	54.5	51.1	50.0	44.7	39.0	32.9
22.7	78.7	76.1	73.4	70.4	67.8	64.7	62.5	56.4	50.3	44.7

7560C,N,XL-GM30

U.S. UNITS

Hyd. GPM	GPM at									
	0 PSI	25 PSI	50 PSI	77 PSI	100 PSI	125 PSI	150 PSI	200 PSI	250 PSI	300 PSI
5	9.0	8.5	7.8	7.3	6.7	6.1	5.5	4.4	3.3	2.2
6	10.5	10.0	9.5	8.9	8.4	7.8	7.3	6.2	5.2	4.1
7	11.9	11.5	11.0	10.4	9.9	9.4	8.9	7.8	6.8	5.7
8	13.7	13.1	12.5	12.0	11.5	10.9	10.4	9.4	8.4	7.3
9	15.2	14.6	14.1	13.6	13.1	12.6	12.1	11.1	10.0	9.1
10	16.9	16.5	15.9	15.4	14.9	14.3	13.9	12.9	11.9	11.0
11	18.6	18.2	17.6	17.1	16.6	16.1	15.6	14.7	13.8	12.9
12	20.1	19.6	19.1	18.6	18.1	17.6	17.1	16.3	15.3	14.5

7560C,N,XL-GM30

METRIC UNITS

Hyd. LPM	LPM at											
	0 BAR	2 BAR	4 BAR	6 BAR	8 BAR	10 BAR	12 BAR	14 BAR	16 BAR	18 BAR	20 BAR	
20	35.8	33.2	30.5	28.1	25.6	23.4	20.9	18.5	15.8	12.6	10.0	
25	42.8	39.5	36.8	34.0	31.8	29.2	26.2	23.7	21.6	18.9	16.4	
30	51.8	49.0	45.8	43.0	40.3	37.9	35.3	33.3	31.1	28.9	26.2	
35	58.1	55.8	52.7	50.1	47.7	45.5	43.1	40.9	38.8	36.3	33.5	
40	67.6	64.8	62.4	60.0	57.7	55.8	53.4	51.3	48.8	46.6	44.1	
45	75.3	72.7	70.4	68.1	66.0	63.8	61.8	59.8	57.8	55.7	53.3	

CAST IRON, NI-RESIST OR SILVER SERIES XL

ROLLER PUMPS

7700 7-Roller Series



Pressure in PSI and BAR	GPM	HP	GPM	HP	GPM	HP
	LPM	HP	LPM	HP	LPM	HP
	@540 RPM		@600 RPM		@800 RPM	
0 PSI	14.2	.23	15.3	.28	22.1	.37
0 BAR	53.7	.23	57.9	.28	83.6	.37
50 PSI	12.9	.56	14.0	.62	20.7	.86
3.4 BAR	48.8	.56	53	.62	78.3	.86
100 PSI	11.9	1.10	13.0	1.20	19.5	1.66
6.9 BAR	45	1.10	49.2	1.20	73.8	1.66
150 PSI	11.2	1.64	12.3	1.80	18.6	2.40
10.3 BAR	42.4	1.64	46.6	1.80	70.4	2.40
200 PSI	10.3	2.22	11.6	2.44	17.8	3.26
13.8 BAR	39	2.22	43.9	2.44	67.4	3.26

FEATURES

- ◆ Max. fluid temperature: 140°F/60°C
- ◆ Port size: 3/4" NPT
- ◆ Housing: Cast Iron (C), Ni-Resist (N) or Silver Series (XL)
- ◆ Shaft rotation: Counter clockwise when looking at the shaft end (Clockwise available)
- ◆ Rollers: Super Rollers standard [Poly (T3) and Teflon® (T2)]
- ◆ Shaft Seals: Viton® standard
- ◆ Recommended PTO torque arm kit 3430-0540
- ◆ Rotor: Cast Iron, Ni-Resist or Silver Series
- ◆ Weight: 14 lbs./6.36 kg

ORDERING INFORMATION

Model Number	Max GPM	Max LPM	Max PSI	Max BAR	Max RPM	Shaft Output		
						U.S.	Metric	Shaft
7700C	22.1	83.7	200	13.8	800	15/16"	23.8 mm	Solid
7700XL	22.1	83.7	200	13.8	800	15/16"	23.8 mm	solid

Teflon rollers - Add Suffix "T2" - (i.e.: 7700C-T2).
 Polypropylene rollers - Add Suffix "T3" - (i.e.: 7700C-T3).
 Reverse rotation* - Add Suffix "R" - (i.e.: 7700C-R).

CAST IRON, NI-RESIST OR SILVER SERIES XL

1700 5-Roller Series



Pressure in PSI and BAR	GPM	HP	GPM	HP	GPM	HP
	LPM	HP	LPM	HP	LPM	HP
	@540 RPM		@600 RPM		@1000 RPM	
0 PSI	25.0	2.7	28.0	.34	45.0	1.42
0 BAR	94.6	2.7	106	.34	170	1.42
50 PSI	21.0	1.18	24.5	1.39	43.0	3.0
3.4 BAR	79.5	1.18	92.7	1.39	163	3.0
100 PSI	19.0	2.13	22.0	2.36	41.0	4.67
6.9 BAR	71.9	2.13	83.3	2.36	155	4.67
150 PSI	17.0	2.89	20.0	3.34	39.0	6.07
10.3 BAR	64.3	2.89	75.7	3.34	148	6.07
200 PSI	15.0	3.85	18.0	4.39	----	----
13.8 BAR	56.8	3.85	681	4.39	----	----

FEATURES

- ◆ Max. fluid temperature: 140°F/60°C
- ◆ Port size: 1" NPT (BSP available on 1700C)
- ◆ Housing: Cast Iron (C), Ni-Resist (N) or Silver Series (XL)
- ◆ Shaft rotation: Counter clockwise when looking at the shaft end (Clockwise available)
- ◆ Rollers: Super Rollers standard [Poly (T3) and Teflon (T2) available]
- ◆ Shaft Seals: Viton standard
- ◆ Recommended PTO torque arm kit 3430-0540
- ◆ Rotor: Cast Iron, Ni-Resist or Silver Series
- ◆ Weight: 19 lbs./8.6 kg

ORDERING INFORMATION

Model Number	Max GPM	Max LPM	Max PSI	Max BAR	Max RPM	Shaft Output		
						U.S.	Metric	Shaft
1700C*	45	170	200	13.8	1000	15/16"	23.8 mm	Solid
1700XL	45	170	200	13.8	1000	15/16"	23.8 mm	solid

* BSP Version - 1700C-BT
 Teflon rollers - Add Suffix "T2" - (i.e.: 1700C-T2).
 Polypropylene rollers - Add Suffix "T3" - (i.e.: 1700C-T3).
 Reverse rotation* - Add Suffix "R" - (i.e.: 1700C-R).

1502 6-Roller Series



Pressure in PSI and BAR	GPM	HP	GPM	HP	GPM	HP
	LPM	HP	LPM	HP	LPM	HP
	@540 RPM		@600 RPM		@1000 RPM	
0 PSI	33.1	.51	36.8	.66	62.1	2.02
0 BAR	125	.51	139	.66	235	2.02
25 PSI	29.7	1.02	33.6	1.15	58.5	3.04
1.7 BAR	112	1.02	127	1.15	221	3.04
50 PSI	27.8	1.45	31.7	1.68	56.9	3.69
3.4 BAR	105	1.45	120	1.68	215	3.69
100 PSI	24.3	2.46	28.3	2.78	53.9	5.31
6.9 BAR	92	2.46	107	2.78	204	5.31
150 PSI	21.0	3.54	25.0	3.95	50.9	7.12
10.3 BAR	79.5	3.54	94.6	3.95	193	7.12

FEATURES

- ◆ Max. fluid temperature: 140°F/60°C
- ◆ Port size: 1-1/2" NPT (BSP available on 1502C)
- ◆ Housing: Cast Iron (C), Ni-Resist (N) or Silver Series (XL)
- ◆ Shaft rotation: Counter clockwise when looking at the shaft end (Clockwise available)
- ◆ Rollers: Super rollers standard [Poly (T3) available]
- ◆ Shaft Seals: Buna-N standard on Cast Iron and Ni-Resist [Viton (O) available]; Viton® standard on Silver Series XL
- ◆ Available PTO adapters (forged steel recommended): See page 76
- ◆ Recommended PTO Torque Arm Kit 3430-0540
- ◆ Rotor: Cast Iron, Ni-Resist or Silver Series
- ◆ Weight: 30 lbs./13.6 kg

ORDERING INFORMATION

Model Number	Max GPM	Max LPM	Max PSI	Max BAR	Max RPM	Shaft Output		
						U.S.	Metric	Shaft
1502C*	62	235	200	13.8	1000	15/16"	23.8 mm	solid
1502XL	62	235	200	13.8	1000	15/16"	23.8 mm	solid

*BSP Version - 1502C-BT
 Polypropylene rollers - Add Suffix "T3" - (i.e.: 1502C-T3).
 Reverse rotation* - Add Suffix "R" - (i.e.: 1502C-R).

CAST IRON OR SILVER SERIES XL, GAS ENGINE DRIVEN

4101C-25, 4101XL-25 Models

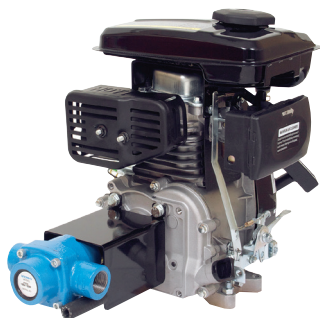

Pressure in PSI and BAR	GPM
BAR	LPM
0 PSI	8.9
0 BAR	34
50 PSI	8.6
3.4 BAR	33
100 PSI	8.3
6.9 BAR	31
150 PSI	8.0
10.3 BAR	30

FEATURES

- ◆ 2.5 HP PowerPro Engine (CARB/EPA approved)
- ◆ Port size: 3/4" NPT
- ◆ Housing: Cast Iron (C) or Silver Series (XL)
- ◆ Rollers: Super rollers standard [Poly (T3) and Teflon® (T2)]
- ◆ Shaft Seals: Viton® standard
- ◆ Rotor: Cast Iron (C) or Silver Series (XL)
- ◆ Weight: 29 lbs./13.1 kg

ORDERING INFORMATION

Model Number	Max GPM	Max LPM	Max PSI	Max BAR	Engine Mfg. & HP
4101C-25	8.9	34.7	100	6.9	PowerPro 2.5 HP
4101XL-25	8.9	34.7	150	10.3	PowerPro 2.5 HP

ROLLER PUMP ACCESSORY SELECTION GUIDE

Description	Series 1500	Series 1700	Series 6500	Series 7560	Series 7700	Series 4000	Series 5200
1000 rpm 1-3/4" Forged Steel PTO Adapter	1320-0080	1320-0080	-----	1320-0080	-----	-----	-----
540 rpm 1-3/8" Quick Coupler	1323-0072	1323-0072	-----	1323-0072	1323-0072	-----	-----
1000 rpm 1-3/8" Quick Coupler	1323-0073	1323-0073	-----	1323-0073	-----	-----	-----
Multi-Speed 1-3/8" Quick Coupler	1323-0076	1323-0076	1321-0012	1321-0013	1321-0013	1321-0012	-----
Steel Shaft Adapter 3/4" x 5/8"	-----	-----	1320-0015	-----	-----	1320-0015	-----
Steel Shaft Adapter 5/8" x 5/8"	-----	-----	1320-0016	-----	-----	1320-0016	-----
Steel Shaft Adapter 540 rpm x 1"	-----	-----	-----	-----	-----	-----	1320-0081
Repair Kits	3430-0387 3430-0386	3430-0437	3430-0380	3430-0381	3430-0384	3430-0390	-----
Torque Arm Kit	-----	3430-0540	3430-0540	3430-0540	3430-0540	-----	-----
Base Kits	-----	3420-0010	3420-0023	3420-0003	3420-0010	3420-0024*	-----
Hydraulic Flange Kit	-----	-----	-----	3430-0636	-----	-----	-----

* For electric motor drive 3 1/2" shaft centerline (4001, 4101).

** For gas engine drive 4 3/16" shaft centerline (4101 only).

ROLLER REPAIR KITS

Kit Number	Pump Series	Description	Estimated Weight Ea.	
			US Units	Metric Units
3430-0387	1502C and 1502N	Roller kit includes: 6 Super Rollers, 1 o-ring gasket, and 2 Buna-N seals	1 lb. 7 oz.	652 g
3430-0437	1700	Roller kit includes: 5 Super Rollers, 1 o-ring gasket, and 2 Viton® seals	1 lb. 5 oz.	595 g
3430-0380	6500	Roller kit includes: 6 Super Rollers, 1 o-ring gasket, and 2 Viton seals	8 oz.	227 g
3430-0381	7560/7700	Roller kit includes: 8 Super Rollers, 1 o-ring gasket, and 2 Viton seals	12 oz.	340 g
3430-0390	4001/4101	Roller kit includes: 4 Super Rollers, 1 o-ring gasket, and 2 Viton seals	3 oz.	85 g

BASE KITS

Kit Number	Pump Series	Description	Estimated Weight Ea.	
			US Units	Metric Units
3420-0024	4001/4101	Base kit for mounting to an electric motor, 3-1/2" shaft centerline. Base kit includes: 1 Base, 2 Bolts and 2 Lock washers	7 oz.	198 g
3420-0023	6500	Base kit includes: 1 Base, 2 Bolts and 2 Lock washers	12 oz.	340 g
3420-0003	7560	Base kit includes: 1 Base, 3 Bolts and 3 Lock washers	1 lb. 10 oz.	737 g
3420-0010	7700/1700	Base kit includes: 1 Base and 4 Bolts	14 oz.	397 g

ROLLER PUMP REPAIR TOOLS AND TOOL KITS

Kit Number	Pump Series	Description
3011-0021	4001/4101	Tool Kit
3010-0003†	4001/4101, 6500	Bearing and seal assembly tool
3010-0004†	4001/4101, 6500	Bearing disassembly tool
3010-0005	1500, 1700, 7560, 7700	Bearing and seal assembly tool
3010-0006	1500, 1700, 7560, 7700	Bearing disassembly tool
3010-0010*†	4001/4101, 6500	Bearing support tool
3010-0014*†	4001/4101, 6500	Bearing race support tool
3010-0020	1500, 1700, 7560, 7700	Bearing support tool
3010-0066*†	1500, 1700, 4001/4101, 6500, 7560, 7700	Wire brush
3010-0067*†	1500, 1700, 4001/4101, 6500, 7560, 7700	Wire brush holder
3020-0009*†	1500, 1700, 4001/4101, 6500, 7560, 7700	Allen wrench; 1/16" hex



PTO AND SHAFT ADAPTERS (FEMALE TO FEMALE)

Part Number	US	Metric	US	Metric	Material	RPM	Pump Model
	PTO (I.D.)	PTO (I.D.)	Pump End (I.D.)	Pump End (I.D.)			
1320-0015	3/4"	19 mm	5/8"	19 mm	steel	*	4000, 6500
1320-0016	5/8"	15.9 mm	5/8"	15.9 mm	steel	*	4000, 6500
1320-0054	3/4"	19 mm	15/16"	23.8 mm	die cast	*	1500, 1700, 7560, 7700

* Refer to recommended pump rpm.



QUICK COUPLERS (FEMALE TO FEMALE)

Part Number	PTO (I.D.)		Pump End (I.D.)		Material	RPM	Pump Model
	US	Metric	US	Metric			
1323-0072	1-3/8" (6 spline)	34.9 mm (6 spline)	15/16"	23.8 mm	Forged steel	540	1500, 1700, 7560, 7700
1323-0073	1-3/8" (21 spline)	34.9 mm (21 spline)	15/16"	23.8 mm	Forged steel	1000	1500, 1700, 7560
1321-0012*	1-3/8" (multi-speed)	34.9 mm (multi-speed)	5/8"	15.9 mm	Die cast	540/1000	4000, 6500
1321-0013*	1-3/8" (multi-speed)	34.9 mm (multi-speed)	15/16"	23.8 mm	Die cast	540/1000	7560, 7700
1323-0076*	1-3/8" (multi-speed)	34.9 mm (multi-speed)	15/16"	23.8 mm	Forged steel	540/1000	1500, 1700, 7560, 7700
1323-0078	1-1/2" (8 spline)	38 mm (8 spline)	5/8"	15.9 mm	Forged steel	1000	4000, 6500

* Multi-speed couplers are compatible with both 6 and 21 spline PTO shafts, refer to OIPM for recommend pump RPM.

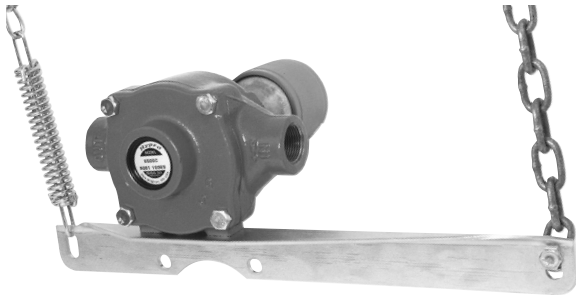

TORQUE ARM KIT (PUMP NOT INCLUDED)

Part Number	Material	RPM	For Pump Series	Estimated Weight Each	
				US Units	Metric
3430-0540	steel	540/1000	1502, 1700, 6500, 7560, and 7700	2 lbs. 4 oz.	1.02 kg



RELIEF VALVES

Part Number	Ports-NPT Inlet (M) Outlet (F)	Max. PSI	Max. BAR	Body Material	Valve Material	Estimated Weight Each	
						US Units	Metric
3300-0002	1/2" M x 1/2" F	200	14	cast bronze	stainless steel ball	10 oz.	283 g
3300-0001	3/4" M x 3/4" F	400	28	cast bronze	stainless steel ball	1 lb. 1 oz.	482 g
3301-0001	3/4" M x 3/4" F	400	28	cast bronze	flat neoprene	1 lb. 2 oz.	510 g
3300-0093	3/4" M x 3/4" F	300	20	cast bronze	stainless steel ball	1 lb. 2 oz.	510 g
3316-0002	1-1/4"	200	14	cast iron	stainless steel cone	2 lbs. 14 oz.	1.3 kg
3300-0015	3/4" M - 3/4" F	150	10	nylon	nylon	6 oz.	170 g
3300-0016	3/4" M - 3/4" F	250	17	nylon	nylon	6 oz.	170 g
3300-0098	3/4" M - 3/4" F	400	28	nylon	nylon	6 oz.	170 g

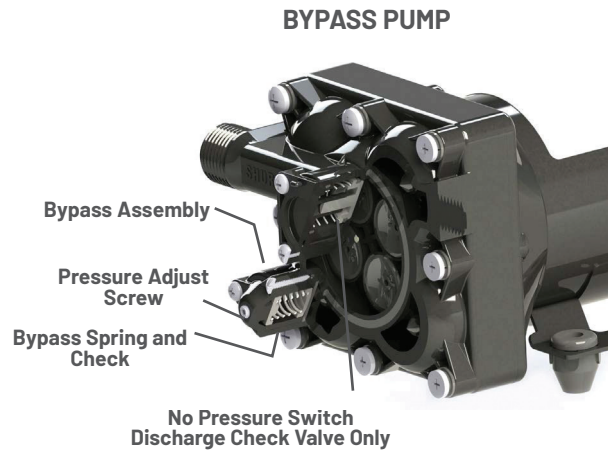
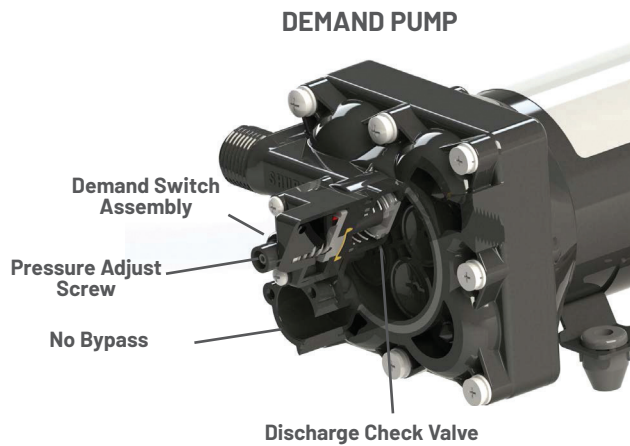

COMMON USES

Applications with a set flow and pressure requirement.
Example: Spray wands on spot sprayers.

HOW IT WORKS

When the operator shuts off the wand, pressure in the line increases to a set point and the pressure switch shuts off the motor. A check valve inside the pump keeps trapped pressure in the line. When the wand is turned back on, pressure in the line decreases. The pressure falls below the set point then restarts the pump

SIZING THE PUMP

Select a pump with a pressure and flow point that is matched to the orifice size in the wand

PRO

- ◆ Saves wear and tear on the pump
- ◆ Extends the service life of the battery

CON

- ◆ Can be difficult to use with variable rate
- ◆ Hand operated spray wands and guns

COMMON USES

Applications where a wide range of flows and pressures may be required. Examples: Spray bar with multiple nozzles, all controlled independently.

HOW IT WORKS

The pump continues to run regardless of pressure in the system. For the spray bar example, the flow rate is different when one nozzle is turned on as opposed to having two or more turned on. As nozzles are turned off, excess flow is bypassed within the pump.

SIZING THE PUMP

Size the pump for the maximum flow rate required with all nozzles spraying

PRO

- ◆ Prevents on/off cycling of pump which can lead to early failure

CON

- ◆ If discharge valve is closed for too long, overheating and damage can occur
- ◆ Constant amp draw can reduce battery power life

5 GPM Bypass and Automatic-Demand Pumps 12 VDC



Bypass



Demand

The field-proven Shurflo 5.3 GPM [20.1 L/min] pump delivers 3.8 GPM at 40 psi [14.4 L/min at 2.75 bar] with current draw of 14 amps. This pump is designed with a Santoprene® diaphragm for chemical resistance and maximum life, as well as Viton® valves for maximum chemical resistance. Also included is a built-in pressure switch, set at 60 PSI [4.14 bar], which protects the pump in the event of dead-heading. The pump is available in the same footprint as other Shurflo pumps, allowing users to upgrade to a higher performance on existing installations.

- ◆ Field-proven pump head design
- ◆ Driven by a 12-volt, sealed motor
- ◆ Self-priming up to 8 feet [2.4 m]
- ◆ Santoprene diaphragm for chemical resistance and maximum life
- ◆ Viton valves provide maximum chemical resistance
- ◆ Automatic demand versions with built-in pressure switch, set at 60 psi [4.14 bar], protects the pump in the event of dead-heading
- ◆ Bypass versions set at 90 psi (5.86 bar), protects the pump in the event of dead heading
- ◆ Available in the same footprint as other Shurflo pumps, allowing users to upgrade to a higher performance on existing installations

BYPASS 12VDC: ORDERING INFORMATION

Part Number	Max GPM	Max LPM	Max PSI	Max BAR	Port Size	Max Draw
5059-3611-D011	5.3	20.1	90	6.2	1/2" npsm*	20.9
5059-3610-D011	5.3	20.1	90	6.2	1/2" NPTF	20.9

* 1/2" -14 American National Standard Straight Pipe Thread
 ** For retail box: change "-D011" to "-D012"

BYPASS 12VDC

Model	PSI	GPM	BAR	L /min	Amps
5059-3611-D011 5059-3610-D011	0	5.3	0	20.1	6.5
	10	4.7	.7	17.8	9.0
	20	4.3	1.4	16.3	10.2
	30	4.1	2.1	15.5	12.0
	40	3.4	2.8	12.9	13.5
	50	2.6	3.4	9.8	15.2
	60	1.8	4.1	6.8	16.9
	70	1.1	4.8	4.2	18.5
	80	0.4	5.5	1.5	20.1
	90	0.0	6.2	0.0	20.9

DEMAND 12VDC: ORDERING INFORMATION

Part Number	Max GPM	Max LPM	Max PSI	Max BAR	Port Size	Max Draw
5059-1311-D011	5.3	20.1	60	3.4	1/2" NPSM*	17.0
5059-1310-D011	5.3	20.1	60	3.4	1/2" NPTF	17.0

* 1/2" -14 American National Standard Straight Pipe Thread
 ** For retail box: change "-D011" to "-D012"

DEMAND 12VDC

Model	PSI	GPM	BAR	L /min	Amps
5059-1311-D011 5059-1310-D011	0	5.3	0	20.1	6.5
	10	4.7	.69	17.8	9.0
	20	4.3	1.38	16.3	11.8
	30	4.1	2.07	15.5	12.4
	40	3.8	2.75	14.4	14.0
	50	3.6	3.45	13.6	15.4
	60	3.4	4.14	12.9	17.0

SHURFLO® 8000 SERIES DIAPHRAGM PUMP

SHURFLO PUMPS

Automatic-Demand Pumps 12 VDC



The 8000 Series diaphragm pump is Shurflo's most widely used agriculture pump. Viton® valve material assures maximum chemical resistance. The unique conical valve design delivers high flow rates at maximum discharge pressures, making the 8000 Series the pump of choice for sprayers used on the farm or around the yard. These 12 VDC pumps deliver up to 1.8 GPM [6.8 L/min] providing maximum performance in a wide range of applications.

- ◆ Self-priming up to 8 vertical feet [2.4m]
- ◆ Chemical-resistant materials
- ◆ Designed for heavy-duty spraying and fluid transfer applications
- ◆ Can run dry without damage
- ◆ Built-in check valve

ORDERING INFORMATION

Part Number	Max GPM	Max LPM	Max PSI	Max BAR	Port Size	Max Draw	Description	Model	PSI	BAR	GPM	L/min	Amps
8000-343-236	1.2	4.5	60	4.1	3/8" NPT-Female	5.8	All Viton® Pump: Viton® valves, Viton® diaphragm, 60 PSI (4.1 bar) demand switch	8000-343-236	20	1.4	0.93	3.5	3.9
									40	2.8	0.84	3.2	4.9
									50	3.4	0.80	3.0	5.3
									60	4.1	0.76	2.9	5.8
8000-541-236*	1.0	3.8	60	4.1	3/8" NPT-Female	3.8	Lawn and Garden Pump: Viton® valves, Santoprene® diaphragm, 60 PSI (4.1 bar) demand switch	8000-541-236	20	1.4	0.79	3.0	2.3
									30	2.1	0.75	2.8	2.8
									40	2.8	0.70	2.6	3.2
									60	4.1	0.62	2.3	3.8
8000-542-136	1.2	4.5	60	4.1	1/2" MSPT-Male	6.0	Low Flow Standard Pump: Viton® valves, Santoprene® diaphragm, 60 PSI (4.1 bar) demand switch	8000-542-136	20	1.4	1.11	4.2	4.1
									40	2.8	0.98	3.7	5.1
									50	3.4	0.93	3.5	5.6
									60	4.1	0.90	3.4	6.0
8000-543-136	1.8	6.8	60	4.1	1/2" MSPT-Male	7.3	Standard Pump: Viton® valves, Santoprene® diaphragm, 60 PSI (4.1 bar) demand switch	8000-543-136	20	1.4	1.26	4.7	5.0
									40	2.8	1.14	4.3	6.2
									50	3.4	1.08	4.1	6.8
									60	4.1	1.02	3.9	7.3
8000-543-236*	1.8	6.8	50	3.4	3/8" NPT-Female	6.4	Standard Pump: Viton® valves, Santoprene® diaphragm, 60 PSI (4.1 bar) demand switch	8000-543-236	30	1.4	1.47	5.5	5.7
									40	2.8	1.41	5.3	5.8
									50	3.4	1.36	5.1	6.4
8000-543-238	1.8	6.8	100	6.9	3/8" NPT-Female	8.7	High Pressure Pump: Viton® valves, Santoprene® diaphragm, 100 PSI (6.9 bar) demand switch	8000-543-238	20	1.4	1.45	5.5	4.2
									40	2.8	1.31	5.0	5.5
									60	4.1	1.22	4.6	6.5
8000-543-138	1.8	6.8	100	6.9	1/2" MSPT-Male	8.7	High Pressure Pump: Viton® valves, Santoprene® diaphragm, 100 PSI (6.9 bar) demand switch	8000-543-138	100	6.9	0.96	3.6	8.7
									20	1.4	1.45	5.5	4.2
									40	2.8	1.31	5.0	5.5
									60	4.1	1.22	4.6	6.5
8000-543-936*	1.8	6.8	50	3.4	3/8" NPT-Female	6.4	Standard Pump w/Wire Harness: Viton® valves, Santoprene® diaphragm, prewired with two wire molded connectors, 60 PSI (4.1 bar) demand switch	8000-543-936	100	6.9	0.96	3.6	8.7
									30	1.4	1.47	5.5	5.7
									40	2.8	1.41	5.3	5.8
									50	3.4	1.36	5.1	6.4
8000-547-189	1.8	6.8	107	7.4	1/2" MSPT-Male	7.0	High Pressure Pump: Viton® valves, Santoprene® diaphragm, 100 PSI (6.9 bar) demand switch with internal bypass	8000-547-189	20	1.4	1.44	5.4	4.1
									40	2.8	1.33	5.0	5.4
									50	3.4	1.27	4.8	6.1
8000-643-236	1.8	6.8	60	4.1	3/8" NPT-Female	6.8	Transfer Pump: Buna valves, Geolast® diaphragm, 60 PSI (4.1 bar) demand switch	8000-643-236	60	4.1	1.22	4.6	6.8
									20	1.4	1.55	5.9	5.5
									30	2.1	1.49	5.6	6.2
									40	2.8	1.43	5.4	6.8
8030-813-239	1.6	6.1	150	9.5	3/8" NPT-Female	12.0	High Pressure Pump: Viton® valves, Santoprene® diaphragm, 150 PSI (10.3 bar) demand switch	8030-813-239	80	5.4	1.20	4.5	9.1
									100	6.9	1.10	4.2	10.1
									150	9.5	0.83	3.1	12.0

* Packaged in quantities of 6. For single packs, replace "8000-" with "8009."

SHURFLO® 8000 SERIES DIAPHRAGM PUMPS

SHURFLO PUMPS

Bypass Pumps 12 VDC



8000-543-250

8000 Series internal bypass pumps are ideal for applications where an automatic demand switch is not desired. Pumps with bypass will continue to run without damage once the bypass pressure is reached. They incorporate a triple chamber design with Viton® elastomers to withstand the toughest applications. Perfect for spot sprayers, foam markers and transfer applications where smooth, consistent flow is needed.

- ◆ Self-priming up to 8 vertical feet [2.4m]
- ◆ Chemical-resistant materials
- ◆ Internal bypass
- ◆ Can run dry without damage

ORDERING INFORMATION

Part Number	Max GPM	Max LPM	Max PSI	Max BAR	Port Size	Max Draw	Description	Model	PSI	BAR	GPM	L/min	Amps
8000-543-250*	1.8	6.8	50	3.4	3/8" NPT-Female	5.5	Standard Bypass Pump: Viton® valves, Santoprene® diaphragm, 45 PSI(3.1BAR) internal bypass	8000-543-250	20	1.4	1.30	4.9	4.0
									30	2.1	1.11	4.2	4.7
									40	2.8	0.69	2.6	5.2
									50	4.1	0.18	0.7	5.5
8000-543-210	1.3	4.9	40	2.8	3/8" NPT-Female	5.5	Standard Bypass Pump: Viton® valves, Santoprene® diaphragm, 35 PSI(2.4 BAR) internal bypass	8000-543-210	10	0.7	1.28	4.8	3.8
									20	1.4	1.19	4.5	4.4
									30	2.1	1.07	4.0	5.0
									40	2.8	0.05	0.19	5.5
8000-543-220	1.5	5.7	60	4.1	3/8" NPT-Female	7.1	Standard Bypass Pump: Viton® valves, Santoprene® diaphragm, 60 PSI(4.1 BAR) internal bypass	8000-543-220	10	0.7	1.52	5.7	3.8
									20	1.4	1.45	5.5	4.5
									30	2.1	1.39	5.3	5.2
									60	4.1	1.12	4.2	7.1
8006-543-250	1.4	5.3	50	3.4	3/8" NPT-Female	5.5	Bypass Pump with Reversed Pumphead: Viton® valves, Santoprene® diaphragm, 45 PSI(3.1BAR) internal bypass	8006-543-250	10	0.7	1.40	5.3	3.4
									20	1.4	1.30	4.9	4.0
									40	2.8	0.69	2.6	5.2
									50	4.1	0.18	0.7	5.5

* Packaged in quantities of 6. For single packs, replace "8000-" with "8009."

SHURFLO® 8000 SERIES DIAPHRAGM PUMPS

Bypass Pumps 12 VDC



8000-543-290

Designed to accommodate applications that have external pressure valves plumbed into the system.

- ◆ Self-priming up to 8 vertical feet [2.4m]
- ◆ Chemical-resistant materials
- ◆ 1/4" adapter for external bypass hook-up
- ◆ Can run dry without damage

ORDERING INFORMATION

Part Number	Max GPM	Max LPM	Max PSI	Max BAR	Port Size	Max Draw	Description	Model	PSI	BAR	GPM	L/min	Amps
8000-543-290	1.8	6.8	100	6.9	3/8" NPT-Female	8.8	Front Adapter Pump: Viton® valves, Santoprene® diaphragm, 1/4" FNPT adapter mounted on switch ports	8000-543-290	20	1.4	1.26	4.7	5.0
									40	2.8	1.14	4.3	6.2
									60	4.1	1.02	3.9	7.3
									80	5.5	0.93	3.5	8.0
									100	6.9	0.84	3.2	8.8

Bypass and Automatic-Demand Pumps 115 VAC and 230 VAC



These Shurflo 8000, 8090 and 8020 Series bypass and demand pumps provide the same reliability as the 12 VDC version, except in a 115 VAC or 230 VAC capacity. They are ideal in agricultural applications that require high pressure with flow rates up to 1.6 GPM [6.1 L/min] and low amp draw. They can be mounted in any position, are compact, and are designed for easy maintenance.

- ◆ Self-priming up to 8 vertical feet [2.4m]
- ◆ Built-in check valve
- ◆ Chemical-resistant materials
- ◆ Corded pump optional
- ◆ Can run dry without damage

BYPASS 115 VAC : ORDERING INFORMATION

Part Number	Max GPM	Max LPM	Max PSI	Max BAR	Port Size	Max Draw	Description
8000-533-250	1.4	5.3	50	3.4	3/8" NPT-Female	0.54	Bypass Pump: Viton® valves, Santoprene® diaphragm, 45 PSI (3.1 bar) Internal Bypass
8020-503-250	1.5	5.7	40	2.8	3/8" NPT-Female	0.56	Bypass Pump with 6' Power Cord: Viton® valves, Santoprene® diaphragm, 45 PSI (3.1 bar) Internal Bypass

BYPASS 115 VAC

Model	PSI	BAR	GPM	L/min	Amps
8000-533-250	10	0.7	1.36	5.1	0.34
	30	2.1	1.05	4.0	0.46
	40	2.8	0.65	2.5	0.51
	50	3.4	0.19	0.7	0.54
8020-503-250	10	0.7	1.40	5.3	0.37
	20	1.4	1.30	4.9	0.44
	30	2.1	1.10	4.2	0.50
	40	2.8	0.80	3.0	0.56

DEMAND 115 VAC: ORDERING INFORMATION

Part Numbers	Max GPM	Max LPM	Max PSI	Max BAR	Port Size	Max Draw	Description
8000-533-236	1.4	5.3	60	4.1	3/8" NPT-Female	0.64	Standard Demand Pump: Viton® valves, Santoprene® diaphragm, 60 PSI (4.1 bar) demand switch
8020-513-236	1.5	5.7	60	4.1	3/8" NPT-Female	0.57	Standard Demand Pump: Viton® valves, Santoprene® diaphragm, 60 PSI (4.1 bar) demand switch with 6 ft (1.8 m) power cord
8020-833-238	1.6	6.1	100	6.9	3/8" NPT-Female	0.95	High Pressure Pump with 6 ft. Power Cord: Viton® valves, Santoprene® diaphragm, 100 PSI (6.9 bar) demand switch
8030-863-239	1.5	5.7	150	9.7	3/8" NPT-Female	1	High Pressure Pump: Viton® valves, Santoprene® diaphragm, 150 PSI (10.3 bar) demand switch

DEMAND 115 VAC

Model	PSI	BAR	GPM	L/min	Amps
8000-533-236	20	1.4	1.15	4.3	0.46
	40	2.8	0.97	3.7	0.55
	50	3.4	0.91	3.4	0.60
	60	4.1	0.85	3.2	0.64
8020-513-236	20	1.4	1.15	4.8	0.40
	40	2.8	0.96	4.1	0.49
	50	3.4	0.90	3.6	0.54
	60	4.1	0.84	3.5	0.57
8020-833-238	20	1.4	1.32	5.0	0.45
	40	2.8	1.14	4.3	0.58
	60	4.1	1.07	4.0	0.70
	100	6.9	0.91	3.4	0.95
8030-863-239	20	1.4	1.24	4.7	0.45
	60	4.1	1.04	3.9	0.66
	120	8.3	0.77	2.9	0.92
	150	9.7	0.63	2.4	1.00

BYPASS 230 VAC: ORDERING INFORMATION

Part Numbers	Max GPM	Max LPM	Max PSI	Max Bar	Port Size	Max Draw	Description
8090-802-289	1.2	4.5	80	5.5	3/8" NPT Female	0.56	Bypass Pump: Viton® valves, Santoprene® diaphragm, 80 PSI (5.5 bar) Internal Bypass
8095-902-260	1.5	5.7	100	6.9	3/8" NPT Female	0.56	Bypass Pump: EPDM valves, Santoprene® diaphragm, 100 PSI (6.9 bar) Internal Bypass

DEMAND & DEMAND/BYPASS 230 VAC: ORDERING INFORMATION

Part Numbers	Max GPM	Max LPM	Max PSI	Max BAR	Port Size	Max Draw	Description
8090-212-246	1.2	4.5	60	4.1	3/8" NPT Female	0.34	Standard Demand Pump: EPDM valves, Santoprene® diaphragm, 80 PSI (4.1 bar) demand switch
8090-801-278	1.3	4.9	100	6.9	3/8" NPT Female	0.56	Demand/Bypass Pump: Viton® valves, Santoprene® diaphragm, *0 PSI (5.5 bar) Internal Bypass, 100 PSI (6.9 bar) demand switch
8090-902-278	1.4	5.3	100	5.5	3/8" NPT Female	0.56	Demand/Bypass Pump: EPDM valves, Santoprene® diaphragm, 80 PSI (5.5 bar) Internal Bypass, 100 PSI (6.9 bar) demand switch

Bypass and Automatic-Demand 12 VDC with Electrical Package



8007-543-850
(Front and Back Shown)

These models include an aesthetically-pleasing molded assembly, housing a rocker-type manual switch with international on/off switch symbols. Wiring is neatly routed into the molded assembly through form fitting entries and strain relieved inside the housing. Fused versions come with an automotive-type fuse housed under a snug fitting cap marked "fuse." Non-fused versions have a raised section.

- ◆ Self-priming up to 8 vertical feet [2.4m]
- ◆ Chemical-resistant materials
- ◆ Internal bypass option
- ◆ Can run dry without damage
- ◆ Built-in on/off switch included
- ◆ 2 pin connector on power leads
- ◆ Available with or without integral fuse
- ◆ Rocker switch protected from the elements by a clear boot

BYPASS 12VDC: ORDERING INFORMATION

Part Number	Max GPM	Max LPM	Max PSI	Max BAR	Port Size	Max Draw	Description
8007-543-850	1.8	6.8	50	3.4	3/8" NPT-Female	5.5	Bypass Pump w/Electrical Package: Viton® valves, Santoprene® diaphragm, 45 PSI (3.1 bar) bypass, Manual on/off switch 2 pin connector and fuse

DEMAND 12VDC: ORDERING INFORMATION

Part Number	Max GPM	Max LPM	Max PSI	Max BAR	Port Size	Max Draw	Description
8007-591-236	1.0	3.8	50	3.4	3/8" NPT-Female	3.7	Demand Pump w/Electrical Package: Viton® valves, Santoprene® diaphragm, 60 PSI (4.1 bar) Demand Switch Manual on/off switch 2 pin connector (8007-543-836 includes fuse)
8007-593-836	1.8	6.8	50	3.4	3/8" NPT-Female	6.4	
8007-543-836	1.8	6.8	50	3.4	3/8" NPT-Female	6.4	

DEMAND 12VDC

Model	PSI	BAR	GPM	L/min	Amps
8007-591-236	30	2.1	0.74	2.8	2.9
	40	2.8	0.69	2.6	3.2
	50	3.4	0.65	2.5	3.7
8007-593-836	30	2.1	1.47	5.5	5.3
	40	2.8	1.41	5.3	5.8
	50	3.4	1.36	5.1	6.4
8007-543-836	30	2.1	1.47	5.5	5.3
	40	2.8	1.41	5.3	5.8
	50	3.4	1.36	5.1	6.4

BYPASS 12VDC

Model	PSI	BAR	GPM	L/min	Amps
8007-543-850	10	0.7	1.40	5.3	3.4
	20	1.4	1.30	4.9	4.0
	30	2.1	1.11	4.2	4.7
	40	2.8	0.69	2.6	5.2
	50	3.4	0.18	0.7	5.5

SHURFLO® 2087 SERIES DIAPHRAGM PUMPS

SHURFLO PUMPS

Automatic-Demand Pump 12 VDC with Electrical Package



2087-593-135
(Front and Back Shown)

These models include an aesthetically-pleasing molded assembly, housing a rocker-type manual switch with international on/off switch symbols. Wiring is neatly routed into the molded assembly through form fitted entries and strain relieved inside the housing.

- ◆ Self-priming up to 12 vertical feet [3.7m]
- ◆ Chemical-resistant materials
- ◆ Can run dry without damage
- ◆ Rocker switch protected from the elements by a clear boot
- ◆ Built-in on/off switch included
- ◆ 2 pin connector on power lead

ORDERING INFORMATION

Part Number	Max GPM	Max LPM	Max PSI	Max BAR	Port Size	Max Draw	Description
2087-593-135 †	3	11.4	50	3.4	1/2" MSPT* Male	8	Standard Demand Pump: Viton® valves, Santoprene® diaphragm, 45 PSI (3.1 bar) demand switch

Model	PSI	BAR	GPM	L/min	Amps
2087-593-135	10	0.7	2.80	10.6	5.3
	20	1.4	2.69	10.2	5.5
	30	2.1	2.36	8.9	6.7
	40	2.8	2.05	7.8	7.7
	50	3.4	1.42	5.4	8.0

* 1/2" - 14 National American Straight Pipe Thread

† Packaged in quantities of 6. For single pack, replace "135" with "435."

SHURFLO® 2088 SERIES DIAPHRAGM PUMPS

Automatic-Demand Pump 12 VDC



2088-343-135

Shurflo 2088 Series diaphragm pumps deliver reliable performance in high flow, moderate pressure applications. They are used in a variety of spot spraying, multi-nozzle spraying and fertilizer drip applications that require flows of up to 3.6 GPM [13.6 L/min]. They are available in a variety of chemical-resistant materials.

- ◆ Self-priming up to 12 vertical feet [3.7m]
- ◆ Chemical-resistant materials
- ◆ Can run dry without damage
- ◆ Automatic demand
- ◆ Built-in check valve (varies by model) prevents back flow of fluid into the solution tank
- ◆ Continuous duty motor on fin-cooled version

ORDERING INFORMATION

Part Number	Max GPM	Max LPM	Max PSI	Max BAR	Port Size	Max Draw	Description
2088-313-145	3.6	13.6	40	2.8	1/2" MSPT* Male	9.5	Standard Pump: with fin cooled motor Viton® valves, Santoprene® diaphragm, 45 PSI (3.1 bar) demand switch
2088-443-144	3.5	13.2	45	3.1	1/2" MSPT* Male	9.1	Standard Pump: Santoprene® valves, Santoprene® diaphragm, 45 PSI (3.1 bar) demand switch
2088-343-135 †	3	11.4	40	2.8	1/2" MSPT* Male	7.7	Standard Pump: Viton® valves, Santoprene® diaphragm, 45 PSI (3.1 bar) demand switch

Model	PSI	BAR	GPM	L/min	Amps
2088-313-145	10	0.7	3.09	11.7	6.4
	20	1.4	2.82	10.7	7.6
	30	2.1	2.49	9.4	8.7
	40	2.8	2.15	8.1	9.5
2088-443-144	10	0.7	2.83	10.7	5.8
	20	1.4	2.56	9.7	7.0
	30	2.1	2.31	8.7	8.0
	40	2.8	2.02	7.6	9.1
2088-343-135	10	0.7	2.80	10.6	5.3
	20	1.4	2.69	10.2	5.5
	30	2.1	2.36	8.9	6.7
	40	2.8	2.05	7.8	7.7

* 1/2" - 14 National American Straight Pipe Thread

† Packaged in quantities of 6. For single pack, replace "135" with "435."

SHURFLO® 2088 SERIES DIAPHRAGM PUMPS

SHURFLO PUMPS

No Control Pumps 12 VDC



2088-343-500

Shurflo 2088 Series diaphragm pumps deliver reliable performance in high flow, moderate pressure applications. They are used in a variety of spraying and transferring applications that require flows of up to 3.3 GPM [12.5 L/min]. They are available in a variety of chemical-resistant materials. They can be mounted in any position and are designed for easy maintenance.

- ◆ Self-priming up to 12 vertical feet [3.7m]
- ◆ Chemical-resistant materials
- ◆ Can run dry without damage
- ◆ Built-in check valve (may vary by models) prevents back flow of fluid through the pump
- ◆ Relief valve in the system required.

ORDERING INFORMATION

Part Number	Max GPM	Max LPM	Max PSI	Max BAR	Port Size	Max Draw	Description	Model	PSI	BAR	GPM	L/min	Amps
2088-343-170	3.3	12.5	50	3.4	1/2" MSPT* Male	9.1	Front Adapter Pump with Electrical Package: Viton® valves, Santoprene® diaphragm, 1/4" FPT adapter mounted on switch port, built-in on/off power switch, fuse holder pre-wired w/2-wire molded connector, no demand switch	2088-343-170	10	0.7	3.00	11.3	5.0
								30	2.1	2.38	9.0	7.5	
								40	2.8	2.14	8.1	8.3	
								50	3.4	1.86	7.0	9.1	
2088-343-500	3.3	12.5	50	3.4	1/2" MSPT* Male	10.1	Front Adapter Pump: Viton® valves, Santoprene® diaphragm, 1/4" FPT adapter mounted on switch port, no demand switch	2088-343-500	10	0.7	2.79	10.6	5.8
								30	2.1	2.26	8.6	8.3	
								40	2.8	1.99	7.5	9.3	
								50	3.4	1.69	6.4	10.1	

* 1/2" - 14 National American Straight Pipe Thread

SHURFLO® 2088 SERIES DIAPHRAGM PUMPS

Automatic-Demand Pumps 115 & 230 VAC



2088-394-144

These Shurflo 2088 Series pumps offer the same reliability as the 12 VDC version except in 115 or 230 VAC capacity. They are used in a variety of spot spraying, mini-bulk transfer and fertilizer applications that require flows of up to 3.2 GPM [12.1 L/min]. They are available in a variety of chemical-resistant materials.

- ◆ Self-priming up to 12 vertical feet [3.7m]
- ◆ Chemical-resistant materials
- ◆ Can run dry without damage
- ◆ Automatic demand
- ◆ Built-in check valve (may vary by model) prevents back flow of fluid into the solution tank

ORDERING INFORMATION

Part Number	Max GPM	Max LPM	Max PSI	Max BAR	Port Size	Max Draw	Description	Model	PSI	BAR	GPM	L/min	Amps
2088-394-144	3	11.4	40	2.8	1/2" MSPT* Male	0.7	115 VAC Pump with 6' power cord: Viton® valves, Santoprene® diaphragm, 45 PSI (3.1 bar) demand switch	2088-394-144	10	0.7	2.40	9.1	.55
								20	1.4	2.20	8.3	.60	
								30	2.1	1.90	7.2	.65	
								40	2.8	1.60	6.0	.70	
2088-394-154	3.2	12.1	40	2.8	1/2" MSPT* Male	0.98	115 VAC Pump: Viton® valves, Santoprene® diaphragm, 45 PSI (3.1 bar) demand switch	2088-394-154	10	0.7	2.71	10.2	.65
								20	1.4	2.41	9.1	.77	
								30	2.1	2.10	8.0	.89	
								40	2.8	1.84	7.0	.98	
2088-564-144	3.0	11.3	50	3.4	1/2" MSPT* Male	0.6	230 VAC Pump: Santoprene® valves, Santoprene® diaphragm, 45 PSI (3.1 bar) demand switch	2088-564-144	10	0.7	2.80	10.6	0.35
								20	1.4	2.50	9.5	0.45	
								30	2.1	2.20	8.3	0.50	
								40	2.8	2.00	7.6	0.55	
								50	3.4	1.70	6.4	0.60	

* 1/2" - 14 National American Straight Pipe Thread

SHURFLO® 166 SERIES DIAPHRAGM PUMPS

SHURFLO PUMPS

Air-Driven Pumps



166-200-36

The Shurflo 166 air-operated demand pumps employ a dual diaphragm design, with a patented fast action switching mechanism allowing for consistent flow and pressure. They are built for the toughest pumping applications and are available in a variety of elastomers that allow them to be compatible with most caustic or acidic fluids. Ideal for chemical transfer, liquid fertilizer injection and agricultural spraying. 2 chamber dual diaphragm.

- ◆ Positive displacement
- ◆ On-demand operation
- ◆ Chemical-resistant polypropylene body
- ◆ 30 to 60 PSI [2.1-4.1 bar]

ORDERING INFORMATION

Part Number	Max GPM	Max LPM	Max PSI	Max BAR	Description
166-200-36	0.6	2.3	30-60	2.1-4.1	Viton® valves and diaphragm
166-200-46	0.6	2.3	30-60	2.1-4.1	Buna valves and diaphragm
166-200-56	0.6	2.3	30-60	2.1-4.1	EPDM valves and diaphragm
166-200-57	0.6	2.3	30-60	2.1-4.1	Santoprene® valves and diaphragm

SHURFLO® POWER TWIN PUMP

Demand Pumps 12VDC



4211-035

Take all the performance and features of the time-tested 2088 series, double it, and the result is the high-flow Power Twin. Delivers an open flow of 6.25 GPM [23.7 L/min] at a mere 8.7 amps. At 40 PSI [2.8 bar], it delivers 3.5 GPM [13.2 L/min] and draws only 17.2 amps. One of the most efficient high-flow self-priming pumps available today, the Power Twin is excellent for transferring, light-duty spraying, and use as a 1:1 proportioning pump.

- ◆ Up to 6.25 GPM [23.7 L/min]
- ◆ Thermally-protected motor with heat sink
- ◆ Self-priming up to 7 vertical feet (2.13 m)
- ◆ Quiet, balanced operation
- ◆ Long-life pressure switch
- ◆ Intake/Discharge manifold optional

ORDERING INFORMATION

Part Number	Max GPM	Max LPM	Max PSI	Max BAR	Port Size	Max Draw	Description	Model	PSI	BAR	GPM	L/min	Amps
4111-035	6.25	23.7	40	2.8	1/2" MPT	17.2	Viton® valves, Santoprene® diaphragm, 45 PSI (3.1 bar) demand switch, manifold with 5/8" barb ports	4111-035	0	0	6.25	23.5	8.7
									10	0.7	5.7	21.6	12.2
									20	1.4	5.0	19.0	14.5
									30	2.1	4.3	16.2	16.1
4211-035	6.25	23.7	40	2.8	1/2" MPT	17.2	Viton® valves, Santoprene® diaphragm, 45 PSI (3.1 bar) demand switch	4211-035	40	2.8	3.5	13.2	17.2
4311-035	6.25	23.7	40	2.8	1/2" MPT	17.2	3/4" manifold kit included.		0	0	6.25	23.5	8.7
									10	0.7	5.7	21.6	12.2
									20	1.4	5.0	19.0	14.5
94-389-00							Manifold Kit 5/8" barb (2) per pump	4211-035	30	2.1	4.3	16.2	16.1
94-389-01							Manifold Kit 3/4" barb (2) per pump		40	2.8	3.5	13.2	17.2

SHURFLO® 9300 SERIES SUBMERSIBLE PUMPS

SHURFLO PUMPS

24 VDC



902-100 CONTROLLER FEATURES:

Boost your DC solar pump's performance by up to 30%. Controller optimizes your solar water pumping system by translating the current and voltage available from your photovoltaic panels, into a combination that is better matched to that needed by the pump. With the optional float switch installed, the controller will automatically stop pumping when the reservoir is full.

- ◆ Operates on 24 VDC
- ◆ Increases daily water output up to 30%
- ◆ System starts pumping earlier in the morning
- ◆ System stops pumping later in the evening
- ◆ Protects pump from low or high volume conditions
- ◆ Terminals for float switch

The Shurflo 9300 series pump offers a solution to your remote water pumping needs. It's rugged, durable and built to last. This pump delivers a steady 1.0 GPM [3.8 L/min] operating at 100 PSI [6.9 bar] maximum at 230 feet [70.1m]. It incorporates a unique, waterblocked cable connector that is impervious to water leakage and condensation problems preventing waterwicking. Great for applications in livestock watering, irrigation, ponds, islands, remote homes and cabins

- ◆ Fits wells 4 inches [10.2 cm] in diameter and larger
- ◆ Accepts a variety of jacketed cables from your power source
- ◆ Runs dry without damage
- ◆ Corrosion-proof housing with stainless steel fasteners
- ◆ Long-life, 24 VDC operation
- ◆ Quick disconnect for easy installation and service

902-200 CONTROLLER FEATURES:

Includes all 902-100 features plus:

- ◆ Switch selectable for 12 VDC or 24 VDC operation
- ◆ Manual Pump On / Off switch for easy pump maintenance
- ◆ Watertight enclosure and cable inlets
- ◆ Includes high/low water level monitor mode with probes and cable so the pump will not run when the well water is too low

ORDERING INFORMATION

Part Number	Max GPM	Max LPM	Max Draw	Description			
9325-043-101	1.8	6.8	4.1	EPDM valves, Santoprene® diaphragm			

Model	Description	Max. Array Input Voltage		Min. Startup Voltage		Shut-down Voltage	Max. Output Current
		12V	24V	12V	24V		
902-100 (LCB-GO)	9300 DC Pump Controller	45 V	N/A	25 V	N/A	28 V	5 Amps
902-200 (LCB-G)	9300 DC Pump Controller	45 V	N/A	25 V	12.5 V	28 V	7 Amps

Model	Vertical Lift				Solar Array	Current
	Feet	Meters	GPH	LPH	Watts	Amps
9325-043-101	20	6.1	117	443	58	1.5
	60	18.3	109	413	78	2.1
	100	30.5	103	390	99	2.6
	140	42.7	99	375	115	3.1
	180	54.9	93	352	135	3.6
	230	70.1	82	310	155	4.1

SHURFLO® 3000 SERIES PUMPS

12 VDC



ORDERING INFORMATION

Part Number	Max GPM	Max LPM	Max PSI	Max BAR	Max Draw
3000-350	2.5	9.5	10	0.7	7.4
3000-100 (115 Volt)	2.5	9.5	10	0.7	7.4

Model	PSI	BAR	Dischg. Ft of Head	GPM	L/min	Amps
3000-350	0	0.0	0.0	3.8	14.4	6.5
	5	0.3	11.5	3.4	12.9	7.1
	10	0.7	23.0	2.5	9.5	7.4

The 3000 Series is suitable for a variety of uses from pumping water to changing oil in cars, trucks and farm equipment. Pumps incorporate thermal overload protection.

Not intended for use with flammable liquids or in flammable environments.

- ◆ Self-priming to 7.5 feet [2.3m] vertical
- ◆ Maximum head of 28 feet [8.5m] (12 PSI [.83 bar])
- ◆ Liquid temps from 40° F to 185° F [4.4°C to 85°C]
- ◆ Thermal overload protection
- ◆ Stainless steel shaft
- ◆ BUNA-N impeller and lip seal
- ◆ Built-in reverse switch and 8 foot [2.4m] cable with battery clips
- ◆ Ports: 3/4" (M) GHT

12 and 24 VDC Demand Pumps



SLV10-AA48
(Front and Back Shown)

The Shurflo SLV is ideal for low volume, intermittent-duty applications requiring a compact pump with low power consumption. Unique design has no metals in the fluid path for maximum chemical resistance. Pump features include automatic demand operation and elastomers that handle a wide variety of chemicals.

Perfect for low volume spraying and transfer. Cost effective yet with high performance and reliability; the SLV offers tremendous value.

- ◆ Automatic demand; 25 PSI [1.72 bar] on/40 PSI [2.8 bar]
- ◆ Self-priming up to 2.5 vertical feet [.76 m]
- ◆ Long-life pressure switch
- ◆ Thermally-protected ball bearing motor with splash-proof housing
- ◆ Internal fan radiates heat; external heat sink not required
- ◆ Integral on/off switch optional

AUTOMATIC DEMAND PUMPS 12 VDC: ORDERING INFORMATION

Part Number	Max GPM	Max LPM	Max PSI	Max BAR	Port Size	Max Draw	Description
SLV10-AA40	1	3.8	30	2.1	3/8" Barb	2.5	Viton® valves, Santoprene® diaphragm, 40 PSI (2.8 bar) demand switch, Integral on/off switch included
SLV10-AA41	1	3.8	30	2.1	3/8" Barb	2.5	Viton® valves, Santoprene® diaphragm, 40 PSI (2.8 bar) demand switch
SLV10-AA48*	1	3.8	30	2.1	3/8" Barb	2.5	Viton® valves, Santoprene® diaphragm, 40 PSI (2.8 bar) demand switch, Manual switch and 2 pin connector 12VDC

* Packaged in quantities of 6, for single pack, add suffix "AB" (i.e.: SLV10-AA48AB).

AUTOMATIC DEMAND PUMP 24 VDC: ORDERING INFORMATION

Part Number	Max GPM	Max LPM	Max PSI	Max BAR	Port Size	Max Draw	Description
SLV10-AB41	1	3.8	30	2.1	3/8" Barb	1.23	Viton® valves, Santoprene® diaphragm, 40 PSI (2.8 bar) demand switch

NO CONTROL TRANSFER PUMP 12 VDC: ORDERING INFORMATION

Part #	Max GPM	Max LPM	Max PSI	Max BAR	Port Size	Max Draw	Description
SLV10-HA01	1	3.8	30	2.1	3/8" Barb	2.5	Viton® valves, Geolast® diaphragm, No demand switch

AUTOMATIC DEMAND PUMPS 12 VDC

Model	PSI	BAR	GPM	L/min	Amps
SLV10-AA40	3	0.2	0.90	3.4	1.8
	10	0.7	0.73	2.8	2.1
	20	1.4	0.62	2.3	2.3
	30	2.1	0.49	1.9	2.5
SLV10-AA41	3	0.2	0.90	3.4	1.8
	10	0.7	0.73	2.8	2.1
	20	1.4	0.62	2.3	2.3
	30	2.1	0.49	1.9	2.5
SLV10-AA48	3	0.2	0.90	3.4	1.8
	10	0.7	0.73	2.8	2.1
	20	1.4	0.62	2.3	2.3
	30	2.1	0.49	1.9	2.5

AUTOMATIC DEMAND PUMP 24 VDC

Model	PSI	BAR	GPM	L/min	Amps
SLV10-AB41	3	0.2	0.90	3.4	0.89
	10	0.7	0.73	2.8	1.00
	20	1.4	0.62	2.3	1.15
	30	2.1	0.49	1.9	1.23

NO CONTROL TRANSFER PUMP 12 VDC

Model	PSI	BAR	GPM	L/min	Amps
SLV10-HA01	3	0.2	0.90	3.4	1.8
	10	0.7	0.73	2.8	2.1
	20	1.4	0.62	2.3	2.3
	30	2.1	0.49	1.9	2.5



DRILL PUMP

Attaches to any standard 1/4" [6.35 mm] drill motor. Ideal for pumping water from appliances, aquariums, water beds, sinks, toilets or drums. Includes a 1/4" [6.35 mm] oil probe that easily allows the transfer of oil from cars, trucks, lawn and garden equipment. Not intended for use with flammable liquids or in flammable environments.

- ◆ Self-priming to 8 feet [2.4m] vertical
- ◆ Pumps liquids 40° F to 120° F [4.4° C to 48.8° C]
- ◆ BUNA impeller and seals
- ◆ 1/4" [6.35 mm] shaft fits standard drills

ORDERING INFORMATION

Part Number	Max GPH	Max LPH	Port Size	Shaft Size
3010-000	200	757	3/4" (M) GHT	1/4"

SHURFLO ACCESSORIES



OIL CHANGE SYSTEM

Makes a messy job clean and easy. Simply install the oil probe in the engine oil dipstick tube, attach the battery clips, and flip the switch. Oil is safely removed and stored in the easy to carry container. Oil should be heated to 140°F for maximum pump efficiency.

- ◆ Complete with necessary tubing and oil storage container
- ◆ 8 foot cable with battery clips
- ◆ Thermal overload protection

ORDERING INFORMATION

Model	Description
8050-305-426	Oil Change System

HEAT SINK



BOWL-STYLE STRAINERS



ORDERING INFORMATION

Model	Description
34-007	5" [12.7 cm] Heat Sink to assist cooling in Continuous-duty applications
34-006	3" [7.6 cm] Heat Sink to assist cooling in Continuous-duty applications

Model	Description
255-223	50 Mesh screen, 1/2" Barb Inlet x 1/2" NPSM Female Outlet
255-313	50 Mesh screen, 1/2" NPSM Male Inlet x 1/2" NPSM Female Outlet, EPDM O-ring
255-323	50 Mesh screen, 1/2" Barb Inlet x 1/2" NPSM Female Outlet, EPDM O-ring
255-646	50 Mesh screen, 3/8" x 3/8" MNPT Poly/Nylon, Viton® O-ring
255-568	50 Mesh screen, 3/8" x 3/8" MNPT Poly/Nylon, EPDM O-ring
255-613	50 Mesh screen, 1/2" NPSM Male Inlet x 1/2" NPSM Female Outlet, Viton O-ring
255-623	50 Mesh screen, 1/2" Barb Inlet x 1/2" NPSM Female Outlet, Viton O-ring
255-413	50 Mesh screen, 1/2" NPSM Male Inlet x 1/2" NPSM Female Outlet, Buna O-ring

SHURFLO FITTINGS



BARBED X PIPE ELBOW

Part Number	Description
244-6128	3/8" [10mm] NPT-Male x 1/2" [12 mm] Barb - Poly



BARBED X PIPE STRAIGHT

Part Number	Description
244-5126	1/2" [12mm] NPT-Male x 1/2" [12 mm] Barb - Nylon



BARB TEE X PIPE

Part Number	Description
T3812T	3/8" [10mm] MNPT-Male x 1/2" Barb Tee - Nylon



SWIVEL HEX NUT ELBOW (USE WITH 2088 SERIES)

Part Number	Description
234-3926	1/2" [12mm] NPT-Female x 1/2" [12 mm] Barb Swivel Hexnut Elbow - Polypro
244-3366	1/2" [12mm] NPT-Female x 1/2" [12 mm] NPT Male Swivel Hex nut Elbow Adaptor - Nylon



SWIVEL HEX WINGNUT STRAIGHT (USE WITH 2088 SERIES)

Part Number	Description
234-2926	1/2" [12mm] NPT-Female x 1/2" [12 mm] Barb - Polypro



The Shurflo AG Runner Transfer Pump System is designed to safely and accurately transfer bulk chemicals to the point of use.

- ◆ Industry leading pump
- ◆ Portable
- ◆ Can be used with a variety of bulk containers
- ◆ Built for rugged service with a heavy-duty welded frame
- ◆ Simple and accurate flow indicator

ORDERING INFORMATION

Part Number	Flow Meter Type	Description
SF-1100-PTS	Pump-mounted (FM-1100)	
SF-1100-PTSi	Inline (FM-1100i)	Chemical Transfer Pump with 12 VDC motor, 20 ft. (6 m) cable, alligator clips and in-line fuse (Part # SF-1100 - EPDM valves or SF-1105 - Viton® valves), electronic flow meter, 1-in. NPT x 12 ft. (3.7 m) EPDM discharge hose with ball valve/spout, and 1-in. NPT x 12 ft. (3.7 m) EPDM inlet hose with 1-in. elbow/ball valve/fitting assembly with locking cam arms
SF-1100-PTSi-00	No Flow Meter	
SF-1105-PTS	Pump-mounted (FM-1100)	
SF-1105-PTSi	Inline (FM-1100i)	



See Mini-Bulk Pump for performance information.

SHURFLO MINI-BULK CHEMICAL TRANSFER SYSTEM



Shurflo Mini-Bulk Chemical Transfer Pumps and Systems are designed specifically for chemical company tanks where the pump is integral to the tank. The SF-1100-REC system is mounted to any tank with a 9-inch, threaded opening. This system allows the pump to recirculate the suspended chemical components prior to transferring to the point of use.

ORDERING INFORMATION

Part Number	Description
SF-1100-REC-DT	Chemical Transfer Pump with 12 VDC motor, 20 ft. (6 m) cable, alligator clips & in-line fuse (Part # SF-1100 - EPDM valves or SF-1105 - Viton® valves), in-line electronic flow meter (Part # FM-1100i), 1-in. NPT x 12 ft. (3.7 m) EPDM discharge hose with ball valve/spout, 3-way valve, tubing and fittings to allow tank recirculation, and 28" (71 cm) dip tube. (SF-1100-REC-DT only)
SF-1105-REC*	



See Mini-Bulk Pump (pg. 108) for performance information.

* Does not come with 28" dip tube. To order dip tube separately use part number 2407-0002



The SF-1100 Series Bulk Chemical Pumps are the industry leader. They are designed for efficiency and power to handle highly viscous fluids. Servicing the SF-1100 series pump is a rare event, but if needed, it can be serviced quickly and easily with only a few hand tools.

- ◆ Specialized EPDM elastics or Viton® option
- ◆ 12 volt DC or 110 volt AC motor option
- ◆ 20 foot (6 m) cord with alligator clips and in-line fuse (DC version), 6 foot (1.8) cord (AC version)
- ◆ Weather protected on/off switch
- ◆ Internal bypass to protect the pump at shut-off
- ◆ 2" MNPT inlet, 1" FNPT outlet
- ◆ Capable of priming up to 12 feet (3.7 m)
- ◆ Max Viscosity: 600-880 Centipoise

ORDERING INFORMATION

Part Number	Valves	Motor
SF-1100	EPDM	12 VDC
SF-1100-110V	EPDM	110 VAC
SF-1105	Viton®	12 VDC

Model	PSI	BAR	GPM	L/min	Amps
SF-1100 and SF-1105	0	0.0	10.7	40	9.3
	5	0.3	10.1	38	10.3
	10	0.7	8.7	33	12.3
	15	1.0	7.6	29	13.9

SHURFLO® MINI-BULK FLOW METERS



The FM-1100 Series Electronic Flow Meter is designed for accurate and easy measuring of transferred chemicals. The FM-1100 Series Flow Meter is an integral component for a complete bulk chemical transfer system.

- ◆ Max. flow of 20 gpm (76 lpm) (.5% accuracy after calibration)
- ◆ Max pressure of 120 psi (8.3 bar)
- ◆ Accurate nutating disk design
- ◆ Large LCD display makes meter reading easy from a distance
- ◆ Simple calibration steps and control button layout
- ◆ Long-life lithium battery
- ◆ Easy-to-service electronics and batteries
- ◆ Available in pump-mounted and hose-end configurations
- ◆ Max Viscosity: 600-880 Centipoise

ORDERING INFORMATION

Part Number	Max GPM	Max LPM	Max PSI	Max BAR	Description
FM-1100	20	76	120	8.3	Pump-mounted meter kit- 1" MNPT inlet & outlet
FM-1100i	20	76	120	8.3	Inline meter kit -1" FNPT inlet & outlet



Part# 94-718-00



Part# 94-719-00

MINI-BULK PUMP KITS FOR SF-1100 SERIES

Part Number	Description
94-718-00	Motor assembly kit used in any SF-1100 series pumps. Kit includes a 12 VDC motor with integrated pump lower housing, built-in on-off switch, 20 foot (6 m) cable, alligator clips and in-line fuse (Support bracket part # 84-1038-08)
94-719-00	Santoprene® diaphragm/lower housing/drive assembly - ready for installation
94-720-00	EPDM valve housing kits include a complete fully-assembled valve housing with o-ring seal* - ready for installation
94-720-05	Viton® valve housing kits include a complete fully-assembled valve housing with o-ring seal* - ready for installation
94-721-00	Polypropylene upper housing - includes o-ring seal* and pump head screws

* Manufacturer recommends replacing the O-ring seal whenever the pump has been dismantled.



Part# 94-732-00



Part# 94-733-00



Part# 94-734-00

MINI-BULK FLOW METER KITS FOR FM-1100 SERIES

Part Number	Description
94-732-00	Flow meter electronics kit includes the front cover assembly and the electronic display with o-ring and batteries. Kit fits both pump-mounted and in-line meters(O-ring part # 5-040-154)
94-733-00	Flow meter housing seal cover kit includes the seal cover, o-ring and screws. Kit fits both pump-mounted and in-line meters.(O-ring part # 5-040-154)
94-734-00	Nutating chamber assembly, including o-ring seal. Kit fits both pump-mounted and in-line meters
94-735-00	90° meter housing with o-ring seal for pump-mounted flow meter. (O-ring part # 5-043-240)
94-736-00	Meter housing with o-ring seal for in-line flow meter. (O-ring part # 5-043-240)



Part# 3320-0064



Part# 94-724-00



Part# 94-725-00

OTHER MINI-BULK PARTS & ACCESSORIES

Part Number	Description
3320-0064	Anti-flow back valve for EPA compliance
94-723-00	Set of red and black alligator clips, including fuse holder
94-724-00	Replacement recirculation lid (Gasket part # 7-155-00)
94-725-00	Replacement recirculation cap

8304B-HM5C Model

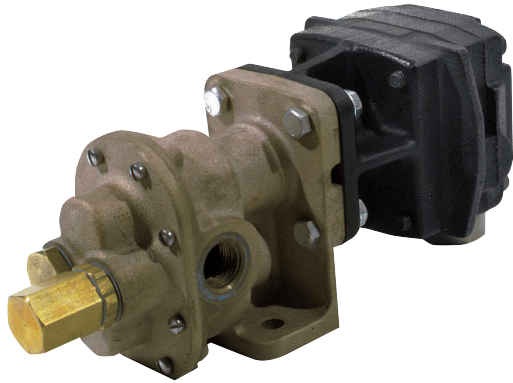

This positive-displacement pump is ideal for de-icing/anti-icing (pre-wet). Combining the pump and motor as a single unit eliminates the need for shaft alignment or Love-Joy® coupling. The unit's compact size allows it to be used in a wide variety of locations and makes it especially attractive for quick, easy retrofit installations.

PUMP

- ◆ Optional pressure relief valve safeguards against pressure buildup (8304BV models)
- ◆ Industry-proven gear pump design, minimal moving parts for longevity
- ◆ Brass material not corroded by salt solutions

MOTOR

- ◆ State-of-the-art internal gear gerotor motor for superior service life
- ◆ Bypass adjustment allows fine tuning of flow control
- ◆ Hydraulic ports: 1/2" NPT inlet, 3/4" NPT outlet with check valve to safeguard against change in flow direction

ORDERING INFORMATION

Model Number	Max GPM	Max LPM	Max PSI	Max BAR	Max Hyd GPM	Max Hyd LPM
8304BV-HM5C	10.4	39.4	100	6.9	4.5	17
8304BV	10.4	39.4	100	6.9	4.5	17

PERFORMANCE

Hydraulic Flow (GPM)	GPM at 0 PSI	GPM at 10 PSI	GPM at 20 PSI	GPM at 30 PSI	GPM at 40 PSI	GPM at 50 PSI	GPM at 60 PSI	GPM at 70 PSI	GPM at 80 PSI	GPM at 90 PSI	GPM at 100 PSI
3.0	6.9	6.5	6.1	5.7	5.3	4.9	4.5	4.1	3.7	3.3	2.9
3.5	8.1	7.7	7.3	6.9	6.6	6.2	5.8	5.4	5.0	4.6	4.2
4.0	9.2	8.9	8.5	8.1	7.8	7.4	7.0	6.7	6.2	5.9	5.5
4.5	10.4	10.1	9.7	9.3	9.0	8.6	8.2	7.9	7.5	7.1	6.8

This data was generated using water as the pumping media. Performance will vary with different viscosity fluids.

Hydraulic pressures vary from 200 to 850 PSI for the performance chart above.

* Product is to be run above 2.0 GPM hydraulic flow.

AQUA-TIGER - 12-VOLT CENTRIFUGAL PUMP

SHURFLO PUMPS

9700B and 9700S Models



- ◆ 12-volt DC motor drive
- ◆ Port sizes: 3/4" NPT inlet, 3/4" NPT outlet
- ◆ Max. fluid temperature: 140°F/60°C
- ◆ Housing: bronze or stainless steel
- ◆ Impeller: bronze (9700B) or stainless steel (9700S)
- ◆ Seal: lip-type Viton (9700B); mechanical (9700S)
- ◆ Weight: 6 lbs./2.7 kg

ORDERING INFORMATION

Model Number	Max GPM	Max LPM	Max PSI	Max BAR	Max Draw
9700B	19	72	7	0.48	11 Amps
9700S	19	72	7	0.48	11 Amps

9700B, 9700S - 13.5 VDC (ALTERNATOR ENGINE RUNNING)

U.S. UNITS

2 PSI		3 PSI		4 PSI		5 PSI		6 PSI		7 PSI	
GPM	AMPS	GPM	AMPS	GPM	AMPS	GPM	AMPS	GPM	AMPS	GPM	AMPS
16.9	5.3	14.0	5.0	12.5	4.9	10	4.9	6.5	4.1	2.7	3.7

9700B, 9700S - 13.5 VDC (ALTERNATOR ENGINE RUNNING)

METRIC UNITS

0.14 BAR		0.21 BAR		0.28 BAR		0.34 BAR		0.41 BAR		0.48 BAR	
LPM	AMPS	LPM	AMPS	LPM	AMPS	LPM	AMPS	LPM	AMPS	LPM	AMPS
62	5.3	53	5.0	47	4.9	38	4.9	25	4.1	10	3.7

High Quality, Field-Proven Engine



- ◆ Available in multiple horsepower options to suit a diverse range of agricultural, industrial, and lawn & garden applications
- ◆ Electric-start option available for quick start-up
- ◆ Dual-element air filter provides highest degree of filtering
- ◆ Cast iron cylinder sleeve for commercial use
- ◆ Overhead valve for cleaner operation on all models
- ◆ Equipped with a robust low-oil sensor to prevent engine damage
- ◆ Engines can be configured to various Hypro pump models or purchased individually
- ◆ Supported with a one-year warranty from Hypro; repair parts available for easy servicing

POWERPRO GASOLINE ENGINES, RECOIL START

CARB & EPA Part Number	EC Part Number	HP	Shaft Size
2549-0043	—	2.5	5/8" Keyed
2541-0045	—	6.5	3/4" Keyed
2541-0046	—	6.5	5/8" Threaded
2541-0048	—	13	1" Keyed

POWERPRO GASOLINE ENGINES, ELECTRIC START

CARB & EPA Part Number	HP	Shaft Size
2541-0053	6.5	3/4" Keyed
2541-0049	13	1" Keyed
2541-0051	13	1" Threaded

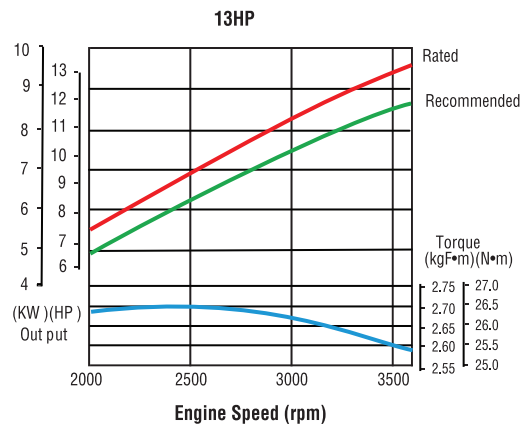
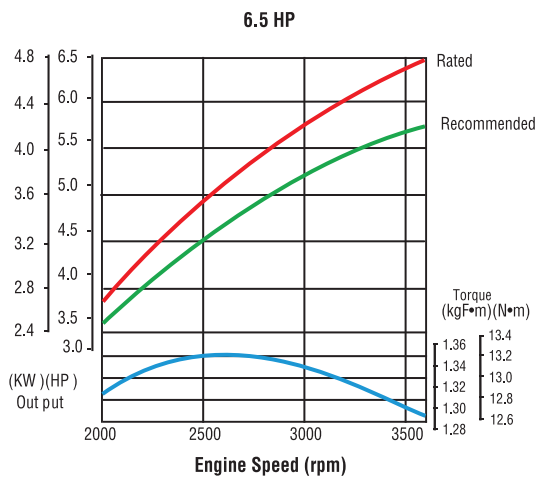
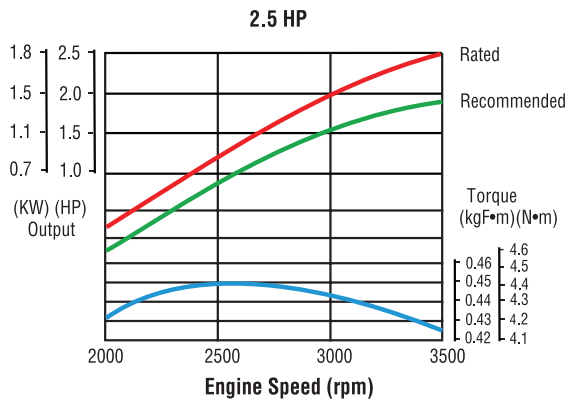

LIMITED WARRANTY ON HYPRO/SHURFLO AGRICULTURAL PUMPS & ACCESSORIES

Hypro/Shurflo (hereafter, "Hypro") agricultural products are warranted to be free of defects in material and workmanship under normal use for the time periods listed below, with proof of purchase.

- Pumps: one (1) year from the date of manufacture, or one (1) year of use. This limited warranty will not exceed two (2) years, in any event.
- Accessories: ninety (90) days of use.

This limited warranty will not apply to products that were improperly installed, misapplied, damaged, altered, or incompatible with fluids or components not manufactured by Hypro. All warranty considerations are governed by Hypro's written return policy.

Hypro's obligation under this limited warranty policy is limited to the repair or replacement of the product. All returns will be tested per Hypro's factory criteria. Products found not defective (under the terms of this limited warranty) are subject to charges paid by the returnee for the testing and packaging of "tested good" non-warranty returns.

No credit or labor allowances will be given for products returned as defective. Warranty replacement will be shipped on a freight allowed basis. Hypro reserves the right to choose the method of transportation.

This limited warranty is in lieu of all other warranties, expressed or implied, and no other person is authorized to give any other warranty or assume obligation or liability on Hypro's behalf. Hypro shall not be liable for any labor, damage or other expense, nor shall Hypro be liable for any indirect, incidental or consequential damages of any kind incurred by the reason of the use or sale of any defective product.

RETURN PROCEDURES

All products must be flushed of any chemical (ref. OSHA section 1910.1200 (d)(e)(f)(g)(h)) and hazardous chemicals must be labeled/tagged before being shipped* to Hypro for service or warranty consideration. Hypro reserves the right to request a Material Safety Data Sheet from the returnee for any pump/product it deems necessary. Hypro reserves the right to "disposition as scrap" products returned which contain unknown fluids. Hypro reserves the right to charge the returnee for any and all costs incurred for chemical testing, and proper disposal of components containing unknown fluids. Hypro requests this in order to protect the environment and personnel from the hazards of handling unknown fluids.

Be prepared to give Hypro full details of the problem, including the model number, date of purchase, and from whom you purchased your product. Hypro may request additional information, and may require a sketch to illustrate the problem.

Contact the appropriate Hypro Service Department to receive a Return Merchandise Authorization number (RMA#). Returns are to be shipped with the RMA number clearly marked on the outside of the package. Hypro shall not be liable for freight damage incurred during shipping. Please package all returns carefully. All products returned for warranty work should be sent shipping charges prepaid:

AMERICAS

HYPRO / PENTAIR
Attention: Service Department
375 Fifth Avenue NW
New Brighton, MN 55112
Service: 800-468-3428
Fax: 651-766-6618
Technical: 800-445-8360
hypro.technical@pentair.com

EUROPE

HYPRO EU Ltd.
Station Road
Longstanton
Cambridge CB24 3DS UK
Service/Technical:
+44 1954 260097
Fax: +44 1954 260245
euagorders@pentair.com

ALL OTHER REGIONS

HYPRO / PENTAIR
Attention: Service Department
375 Fifth Avenue NW
New Brighton, MN 55112
Service: 800-468-3428
Fax: 651-766-6618
Technical: 800-445-8360
hypro.technical@pentair.com

*Carriers, including U.S.P.S., airlines, UPS, ground freight, etc., require specific identification of any hazardous material being shipped. Failure to do so may result in a substantial fine and/or prison term. Check with your shipping company for specific instructions.



HYPRO

375 Fifth Avenue NW,
New Brighton, MN 55112, USA
Main: 651.766.6300 | Technical: 800.445.8360
Order: 800.424.9776 | Fax: 800.323.6496
hypro.sales@pentair.com

HYPRO EU LTD.

Unit 9, Bourn Quarter,
Bourn, Caldecote,
Cambridge CB23 7FW UK
+44 1954 260097 | Fax: +44 1954 260245
euaginfo@pentair.com
Order: euagorders@pentair.com

CENTRAL & SOUTH AMERICA

+55 (11) 3317-5085
vendas.pwdb@pentair.com

All indicated Pentair trademarks and logos are property of Pentair. Third party registered and unregistered trademarks and logos are the property of their respective owners.

Briggs & Stratton® is a registered trademark of Briggs & Stratton Corporation
Honda® is a registered trademark of Honda Motor Co., Ltd.,
Roundup® is a registered trademark of Monsanto Co.,
Teflon® is a registered trademark of E.I. DuPont de Nemours and Co.,
Viton® is a registered trademark of DuPont.
Kynar® is a registered trademark of Arkema, Inc.
Desmopan® is a registered trademark of Bayer Aktiengesellschaft, Farbenfabriken.

©2024 Pentair, Inc. All Rights Reserved.

HYP01(03/01/24)